

Operation Manual

Mode d'emploi

Multi-CD control DSP High power CD/MP3/WMA
player with FM/AM tuner

Syntoniseur FM/AM et lecteur de CD/MP3/WMA avec
DSP, "Puissance élevée", avec contrôleur pour lecteur
de CD à chargeur

DEH-P8600MP

English

Français

SUPER  **TUNER III** 

Thank you for buying this Pioneer product.

Please read through these operating instructions so you will know how to operate your model properly. *After you have finished reading the instructions, keep this manual in a safe place for future reference.*

01 Before You Start

- Information to User **6**
- For Canadian model **6**
- About this unit **6**
- About this manual **6**
- After-sales service for Pioneer products **6**
- Product registration **6**
- Precautions **7**
- Features **7**
- About WMA **7**
- Resetting the microprocessor **8**
- About the demo mode **8**
 - Reverse mode **8**
 - Feature demo **8**
- Use and care of the remote control **9**
 - Installing the battery **9**
 - Using the remote control **9**
 - FUNCTION button and AUDIO button **9**
- About the XM READY mark **10**

02 What's What

- Head unit **11**
- Remote control **11**

03 Basic Operations

- Turning the unit on **13**
- Selecting a source **13**
- Loading a disc **13**
- Adjusting the volume **14**
- Turning the unit off **14**
- Protecting your unit from theft **14**
 - Removing the front panel **14**
 - Attaching the front panel **15**

04 Tuner

- Listening to the radio **16**
- Introduction of advanced tuner operation **17**

- Storing and recalling broadcast frequencies **17**
- Tuning in strong signals **18**
- Storing the strongest broadcast frequencies **18**
- Selecting stations from the preset channel list **18**

05 Built-in CD Player

- Playing a CD **19**
- Selecting a track directly **19**
- Introduction of advanced built-in CD player operation **20**
- Repeating play **20**
- Playing tracks in a random order **21**
- Scanning tracks of a CD **21**
- Pausing CD playback **21**
- Selecting the search method **21**
- Searching every 10 tracks in the current disc **21**
- Using compression and BMX **22**
- Entering disc titles **22**
- Using CD TEXT functions **23**
 - Displaying titles on CD TEXT discs **23**
 - Scrolling titles in the display **23**
 - Selecting tracks from the track title list **23**

06 MP3/WMA/WAV Player

- Playing MP3/WMA/WAV **24**
- Selecting a track directly in the current folder **25**
- Introduction of advanced built-in CD player (MP3/WMA/WAV) operation **26**
- Repeating play **26**
- Playing tracks in a random order **27**
- Scanning folders and tracks **27**
- Pausing MP3/WMA/WAV playback **27**

- Selecting the search method **27**
- Searching every 10 tracks in the current folder **28**
- Switching the tag display **28**
- Using compression and BMX **28**
- Displaying text information on MP3/WMA/WAV disc **29**
 - When playing back an MP3/WMA disc **29**
 - When playing back a WAV disc **29**
- Scrolling text information in the display **29**
- Selecting tracks from the file name list **30**

07 Multi-CD Player

- Playing a CD **31**
- Selecting a track directly **31**
- 10-disc multi-CD player **32**
- Introduction of advanced multi-CD player operation **32**
- Repeating play **33**
- Playing tracks in a random order **33**
- Scanning CDs and tracks **33**
- Pausing CD playback **34**
- Using ITS playlists **34**
 - Creating a playlist with ITS programming **34**
 - Playback from your ITS playlist **34**
 - Erasing a track from your ITS playlist **35**
 - Erasing a CD from your ITS playlist **35**
- Using disc title functions **35**
 - Entering disc titles **36**
 - Selecting discs from the disc title list **36**
- Using CD TEXT functions **37**
 - Displaying titles on CD TEXT discs **37**
 - Scrolling titles in the display **37**

- Selecting tracks from the track title list **37**
- Using compression and bass emphasis **38**

08 XM tuner

- Listening to the XM **39**
- Introduction of advanced XM tuner operation **40**
- Switching the XM display **40**
- Storing and recalling broadcast stations **40**
- Switching the XM channel select setting **40**
 - Selecting the channel in the channel category **41**
- Selecting the XM channel directly **41**
- Display the ID code **41**
 - Channel number select setting **41**
 - Channel category select setting **41**

09 TV tuner

- Watching the TV tuner **42**
- Storing and recalling broadcast stations **42**
- Storing the strongest broadcast stations sequentially **43**
- Selecting stations from the preset channel list **43**

10 DVD Player

- Playing a disc **44**
- Selecting a disc **44**
- Introduction of advanced DVD player operation **45**
- Repeating play **45**
- Pausing disc playback **46**
- Playing tracks in a random order **46**
- Scanning tracks of a CD **46**
- Using ITS playlists **46**
- Using disc title functions **46**
 - Entering disc titles **46**

11 Audio Adjustments

- Adjusting the audio easily **47**
- Adjusting the audio finely **47**
- Extra functions **47**
- Introduction of audio adjustments **47**
- Using the position selector **48**
- Using balance adjustment **48**
- Using the time alignment **49**
 - Adjusting the time alignment **49**
- Using subwoofer output **50**
 - Adjusting subwoofer settings **50**
 - Adjusting low pass filter attenuation slope **51**
- Using the high pass filter **51**
 - Muting the speaker units (filters) **51**
 - Setting the high pass filter for front speakers **51**
 - Setting the high pass filter for rear speakers **52**
- Using the auto-equalizer **52**
- Recalling equalizer curves **52**
- Adjusting equalizer curves **53**
- Adjusting 13-band graphic equalizer **53**
- Using BBE sound **54**
- Adjusting loudness **54**
- Using automatic sound levelizer **54**
- Adjusting source levels **55**
- Auto TA and EQ (auto-time alignment and auto-equalizing) **55**
 - Before operating the auto TA and EQ function **56**
 - Carrying out auto TA and EQ **56**

12 Initial Settings

- Adjusting initial settings **58**
- Setting the clock **58**
- Switching the auxiliary setting **58**
- Switching the dimmer setting **59**
- Adjusting the brightness **59**

- Correcting distorted sound **59**
- Switching the sound muting/attenuation **59**
- Switching the warning tone **60**
- Using the feature demo **60**
- Using reverse mode **60**
- Switching the font **60**
- Switching the Ever Scroll **60**
- Switching the flap auto open **61**

13 Other Functions

- Turning the clock display on or off **62**
- Using the AUX source **62**
 - Selecting AUX as the source **62**
 - Setting the AUX title **62**
- Using different entertainment displays **63**
- Using the PGM button **63**
- Rewriting the entertainment displays **63**

Additional Information

- Understanding built-in CD player error messages **65**
- Understanding auto TA and EQ error messages **65**
- Understanding error message on rewriting the entertainment displays **65**
- CD player and care **66**
- CD-R/CD-RW discs **66**
- MP3, WMA and WAV files **67**
 - MP3 additional information **67**
 - WMA additional information **68**
 - WAV additional information **68**
- About folders and MP3/WMA/WAV files **68**
- Terms **70**
- Specifications **72**



Dear Customer:

Selecting fine audio equipment such as the unit you've just purchased is only the start of your musical enjoyment. Now it's time to consider how you can maximize the fun and excitement your equipment offers. This manufacturer and the Electronic Industries Association's Consumer Electronics Group want you to get the most out of your equipment by playing it at a safe level. One that lets the sound come through loud and clear without annoying blaring or distortion—and, most importantly, without affecting your sensitive hearing.

Sound can be deceiving. Over time your hearing "comfort level" adapts to higher volumes of sound. So what sounds "normal" can actually be loud and harmful to your hearing. Guard against this by setting your equipment at a safe level BEFORE your hearing adapts.

To establish a safe level:

- Start your volume control at a low setting.
- Slowly increase the sound until you can hear it comfortably and clearly, and without distortion.

Once you have established a comfortable sound level:

- Set the dial and leave it there.

Taking a minute to do this now will help to prevent hearing damage or loss in the future. After all, we want you listening for a lifetime.

We Want You Listening For A Lifetime

Used wisely, your new sound equipment will provide a lifetime of fun and enjoyment. Since hearing damage from loud noise is often undetectable until it is too late, this manufacturer and the Electronic Industries Association's Consumer Electronics Group recommend you avoid prolonged exposure to excessive noise. This list of sound levels is included for your protection.

Decibel

<u>Level</u>	<u>Example</u>
30	Quiet library, soft whispers
40	Living room, refrigerator, bedroom away from traffic
50	Light traffic, normal conversation, quiet office
60	Air conditioner at 20 feet, sewing machine
70	Vacuum cleaner, hair dryer, noisy restaurant
80	Average city traffic, garbage disposals, alarm clock at two feet

THE FOLLOWING NOISES CAN BE DANGEROUS UNDER CONSTANT EXPOSURE

90	Subway, motorcycle, truck traffic, lawn mower
100	Garbage truck, chain saw, pneumatic drill
120	Rock band concert in front of speakers, thunderclap
140	Gunshot blast, jet plane
180	Rocket launching pad

Information courtesy of the Deafness Research Foundation.



Information to User

Alteration or modifications carried out without appropriate authorization may invalidate the user's right to operate the equipment.



For Canadian model

This Class B digital apparatus complies with Canadian ICES-003.



About this unit

The tuner frequencies on this unit are allocated for use in North America. Use in other areas may result in poor reception.



Important (Serial number)

The serial number is located on the bottom of this unit. For your own security and convenience, be sure to record this number on the enclosed warranty card. 

About this manual

This unit features a number of sophisticated functions ensuring superior reception and operation. All the functions have been designed for the easiest possible use, but many are not self-explanatory. This operation manual will help you benefit fully from this unit's potential and to maximize your listening enjoyment. We recommend that you familiarize yourself with the functions and their operation by reading through the manual before you begin using this unit. It is especially important that you read and observe precautions noted on the next page and in other sections. 

After-sales service for Pioneer products

Please contact the dealer or distributor from where you purchased this unit for after-sales service (including warranty conditions) or any other information. In case the necessary information is not available, please contact the companies listed below:

Please do not ship your unit to the companies at the addresses listed below for repair without advance contact.

U.S.A.

Pioneer Electronics (USA) Inc.
CUSTOMER SUPPORT DIVISION
P.O. Box 1760
Long Beach, CA 90801-1760
800-421-1404

CANADA

Pioneer Electronics of Canada, Inc.
CUSTOMER SATISFACTION DEPARTMENT
300 Allstate Parkway
Markham, Ontario L3R 0P2
(905) 479-4411
1-877-283-5901

For warranty information please see the Limited Warranty sheet included with this unit. 

Product registration

Visit us at the following site:

<http://www.pioneerelectronics.com>

- 1 Register your product. We will keep the details of your purchase on file to help you refer to this information in the event of an insurance claim such as loss or theft.

Before You Start

- 2 Receive updates on the latest products and technologies.
- 3 Download owner's manuals, order product catalogues, research new products, and much more. 

Precautions

WARNING:

Handling the cord on this product or cords associated with accessories sold with the product will expose you to lead, a chemical known to the State of California and other governmental entities to cause cancer and birth defects or other reproductive harm. ***Wash hands after handling.***

CAUTION:

USE OF CONTROL OR ADJUSTMENT OR PERFORMANCE OF PROCEDURES OTHER THAN THOSE SPECIFIED HEREIN MAY RESULT IN HAZARDOUS RADIATION EXPOSURE.

CAUTION:

THE USE OF OPTICAL INSTRUMENTS WITH THIS PRODUCT WILL INCREASE EYE HAZARD.

- Keep this manual handy as a reference for operating procedures and precautions.
- Always keep the volume low enough so that you can hear sounds from outside the car.
- Protect this unit from moisture.
- If the battery is disconnected or discharged, the preset memory will be erased and must be reprogrammed. 

Features

CD playback

Music CD/CD-R/CD-RW playback is possible.

MP3 file playback

You can play back MP3 files recorded on CD-ROM/CD-R/CD-RW (ISO9660 Level 1/Level 2 standard recordings).

- Supply of this product only conveys a license for private, non-commercial use and does not convey a license nor imply any right to use this product in any commercial (i.e. revenue-generating) real time broadcasting (terrestrial, satellite, cable and/or any other media), broadcasting/streaming via internet, intranets and/or other networks or in other electronic content distribution systems, such as pay-audio or audio-on-demand applications. An independent license for such use is required. For details, please visit <http://www.mp3licensing.com>.

WMA file playback

You can play back WMA files recorded on CD-ROM/CD-R/CD-RW (ISO9660 Level 1/Level 2 standard recordings).

WAV file playback

You can play back WAV files recorded on CD-ROM/CD-R/CD-RW (Linear PCM (LPCM)/MS ADPCM recordings). 

About WMA



The Windows Media™ logo printed on the box indicates that this unit can play back WMA data.

WMA is short for Windows Media Audio and refers to an audio compression technology that is developed by Microsoft Corporation. WMA data can be encoded by using Windows Media Player version 7 or later.

Microsoft, Windows Media, and the Windows logo are trademarks, or registered trademarks of Microsoft Corporation in the United States and/or other countries.

Notes

- With some applications used to encode WMA files, this unit may not operate correctly.
- With some applications used to encode WMA files, album names and other text information may not be correctly displayed. 

Resetting the microprocessor

The microprocessor must be reset under the following conditions:

- Prior to using this unit for the first time after installation
- If the unit fails to operate properly
- When strange or incorrect messages appear on the display

- **Press RESET with a pen tip or other pointed instrument.**

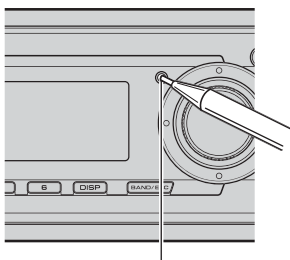

RESET button



About the demo mode

This unit features two demonstration modes. One is the reverse mode, the other is the feature demo mode.

Important

The red lead (ACC) of this unit should be connected to a terminal coupled with ignition switch on/off operations. If this is not done, the vehicle battery may be drained.

Reverse mode

If you do not perform an operation within about 30 seconds, screen indications start to reverse, and then continue reversing every 10 seconds. Pressing button **5** when power to this unit is turned off while the ignition switch is set to ACC or ON cancels the reverse mode. Press button **5** again to start the reverse mode.

- Some entertainment displays may not operate the reverse mode.

Feature demo

The feature demo automatically starts when power to this unit is turned off while the ignition switch is set to ACC or ON. Pressing button **6** during feature demo operation cancels the feature demo mode. Press button **6** again to start the feature mode. Remember that if the feature demo continues operating when the car engine is turned off, it may drain battery power. 

Before You Start

Use and care of the remote control

Installing the battery

Slide the tray out on the back of the remote control and insert the battery with the plus (+) and minus (-) poles pointing in the proper direction.

- When using for the first time, pull out the film protruding from the tray.

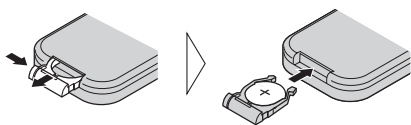

WARNING

Keep the battery out of the reach of children. Should the battery be swallowed, immediately consult a doctor.



CAUTION

- Use only one **CR2025 (3 V)** lithium battery.
- Remove the battery if the remote control is not used for a month or longer.
- Do not recharge, disassemble, heat or dispose of the battery in fire.
- Do not handle the battery with metallic tools.
- Do not store the battery with metallic materials.
- In the event of battery leakage, wipe the remote control completely clean and install a new battery.
- When disposing of used batteries, please comply with governmental regulations or environmental public institutions' rules that apply in your country/area.

Using the remote control

Point the remote control in the direction of the front panel to operate.

- The remote control may not function properly in direct sunlight.



Important

- Do not store the remote control in high temperatures or direct sunlight.
- Do not let the remote control fall onto the floor, where it may become jammed under the brake or accelerator pedal.

FUNCTION button and AUDIO button

You can also select the desired mode by **FUNCTION** button and **AUDIO** button on the remote control. But operation of **FUNCTION** button and **AUDIO** button on the remote control differs from the operation of **MULTI-CONTROL** on the head unit. When operating the remote control, switch through the modes as described below to select the mode.

FUNCTION button operation

- **Press FUNCTION to select the desired mode (e.g., built-in CD player).**

Press **FUNCTION** repeatedly to switch between the following modes:

PLAY MODE—RANDOM—SCAN—PAUSE—SEARCH MODE—TAG READ—COMP/BMX—DISC TITLE



Note

Refer to *Introduction of advanced built-in CD player operation* on page 20.

AUDIO button operation

- **Press AUDIO to select the desired mode.**

Press **AUDIO** repeatedly to switch between the following modes:

FAD/BAL—POSI—TA 1—TA 2—LOUD—
 G.EQ 1—G.EQ 2—SW 1—SW 2—SW 3—
 F-HPF 1—F-HPF 2—R-HPF 1—R-HPF 2—BBE
 —AUTO-EQ—ASL—SLA

**Note**

Refer to *Introduction of audio adjustments* on page 47. 

About the XM READY mark

The XM READY mark printed on the front panel indicates that the Pioneer XM tuner (sold separately) can be controlled by this unit. Please inquire to your dealer or nearest authorized Pioneer service station regarding the XM tuner that can be connected to this unit. For XM tuner operation, please refer to the XM tuner owner's manual.

**Notes**

- XM Satellite Radio is developing a new band of radio in the U.S.A.



The system will use direct satellite-to-receiver broadcasting technology to provide listeners in their cars and at home with crystal-clear sound seamlessly from coast to coast. XM will create and package up to 100 channels of digital-quality music, news, sports, talk and children's programming.

- The XM name and related logos are trademarks of XM Satellite Radio Inc. 

What's What

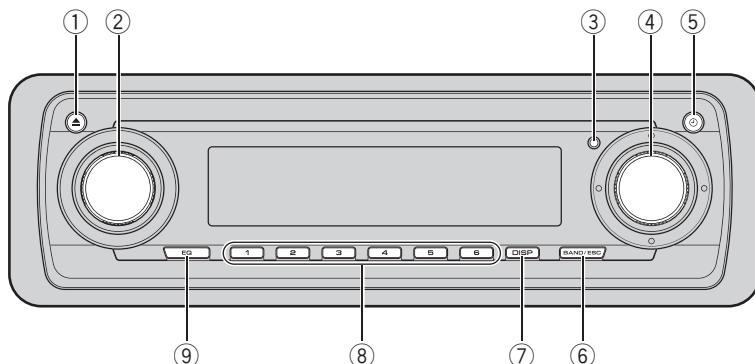

Head unit

① EJECT button

Press to eject a CD from your built-in CD player.
Press and hold to open or close the front panel.

② SOURCE button, VOLUME

This unit is turned on by selecting a source. Press to cycle through all the available sources.
Rotate it to increase or decrease the volume.

③ RESET button

Press to return to the factory settings (initial settings).

④ MULTI-CONTROL

Push up, down, left or right to do manual seek tuning, fast forward, reverse and track search controls. Also used for controlling functions.

⑤ CLOCK button

Press to change to the clock display.

⑥ BAND/ESC button

Press to select among three FM bands and one AM band and to cancel the control mode of functions.

⑦ DISPLAY button

Press to select different displays.

⑧ 1-6 buttons

Press for preset tuning and disc number search when using a multi-CD player.

⑨ EQ button

Press to select various equalizer curves. 

Remote control

Operation is the same as when using the buttons on the head unit.

⑩ VOLUME buttons

Press to increase or decrease the volume.

⑪ AUDIO button

Press to select various sound quality controls.

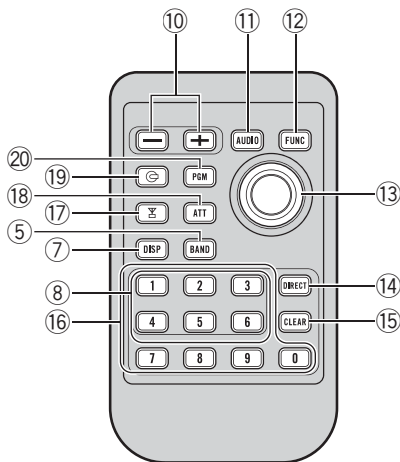

⑫ FUNCTION button

Press to select functions.

⑬ Joystick

Move to do manual seek tuning, fast forward, reverse and track search controls. Also used for controlling functions.

- You can perform same operation as **MULTI-CONTROL** on the head unit, except the turning operation.

⑭ DIRECT button

Press to directly select the desired track.

⑮ CLEAR button

Press to cancel the input number when **0-9** are used.

⑯ 0-9 buttons

Press to directly select the desired track, preset tuning or disc. Buttons **1-6** can operate the preset tuning for the tuner or disc number search for the multi-CD player.

⑰ TUNER button

Press to select the tuner as the source.

⑱ ATT button

Press to quickly lower the volume level, by about 90%. Press once more to return to the original volume level.

⑲ CD button

Press to select the built-in or multi-CD player as the source.

⑳ PGM button

Press to operate the preprogrammed functions for each source. (Refer to *Using the PGM button* on page 63.) ▣

Basic Operations

Turning the unit on

- **Press SOURCE to turn the unit on.**

When you select a source the unit is turned on. 

Selecting a source

You can select a source you want to listen to. To switch to the built-in CD player, load a disc in the unit (refer to this page).

- **When using the head unit, press SOURCE to select a source.**

Press **SOURCE** repeatedly to switch between the following sources:

XM tuner—Tuner—Television—DVD player/Multi-DVD player—Built-in CD player—Multi-CD player—External unit 1—External unit 2—AUX

- **When using the remote control, press TUNER or CD to select a source.**

Press each button repeatedly to switch between the following sources:

TUNER: XM tuner—Tuner—Television—Sources off
CD: DVD player/Multi-DVD player—Built-in CD player—Multi-CD player—Sources off

Notes

- In the following cases, the sound source will not change:
 - When there is no unit corresponding to the selected source connected to this unit.
 - When there is no disc in the unit.
 - When there is no disc in the DVD player.
 - When there is no magazine in the multi-CD player.
 - When there is no magazine in the multi-DVD player.

— When the AUX (auxiliary input) is set to off (refer to page 58).

- External unit refers to a Pioneer product (such as one available in the future) that, although incompatible as a source, enables control of basic functions by this unit. Two external units can be controlled by this unit. When two external units are connected, the allocation of them to external unit 1 or external unit 2 is automatically set by this unit.
- When this unit's blue/white lead is connected to the car's auto-antenna relay control terminal, the car's antenna extends when this unit's source is turned on. To retract the antenna, turn the source off. 

Loading a disc

1 Press EJECT to open the front panel.

CD loading slot appears.

- After a CD has been inserted, press **SOURCE** to select the built-in CD player.

2 Insert a CD into the CD loading slot.

Front panel is closed automatically, and playback will start.

CD loading slot

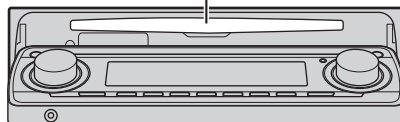

- You can eject a CD by pressing **EJECT**.

Notes

- The built-in CD player plays one, standard, 12-cm or 8-cm (single) CD at a time. Do not use an adapter when playing 8-cm CDs.
- Do not insert anything other than a CD into the CD loading slot.

- If you cannot insert a disc completely or if after you insert a disc the disc does not play, check that the label side of the disc is up. Press **EJECT** to eject the disc, and check the disc for damage before inserting it again.
- You can eject the CD by pressing and holding **EJECT** with opening the front panel when the CD loading or ejecting cannot operate properly.
- If the built-in CD player does not operate properly, an error message such as **ERROR-11** may be displayed. Refer to *Understanding built-in CD player error messages* on page 65. 

Adjusting the volume

- Use **VOLUME** to adjust the sound level.

With the head unit, rotate **VOLUME** to increase or decrease the volume.

With the remote control, press **VOLUME** to increase or decrease the volume. 

Turning the unit off

- Press **SOURCE** and hold until the unit turns off. 

Protecting your unit from theft

The front panel can be detached from the head unit and stored in the protective case provided to discourage theft.

- If the front panel is not detached from the head unit within five seconds of turning off the ignition, a warning tone will sound and the front panel will open.

- You can turn off the warning tone. See *Switching the warning tone* on page 60.
- You can turn off the flap auto open. See *Switching the flap auto open* on page 61.

Important

- Never use force or grip the display and the buttons too tightly when removing or attaching.
- Avoid subjecting the front panel to excessive shocks.
- Keep the front panel out of direct sunlight and high temperatures.
- A few seconds after turning the ignition switch to on or off, the front panel automatically moves. When this happens, your fingers may become jammed in the panel, so keep your hands away from it.
- When removing the front panel, be sure to hold the corrugated release button on the rear of the front panel while pulling.

Removing the front panel

- 1 Press and hold **EJECT** to open the front panel.

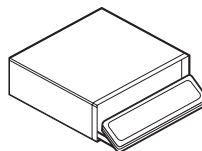

- 2 Slide and remove the front panel toward you.

Take care not to grip it too tightly or to drop it.

Basic Operations

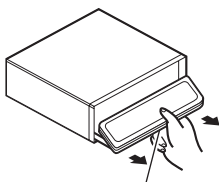

Release button

- 3 Put the front panel into the protective case provided for safe keeping.

Attaching the front panel

- 1 Make sure the inner cover is closed.
- 2 Replace the front panel by clipping it into place.

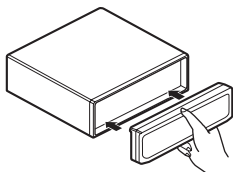

Listening to the radio

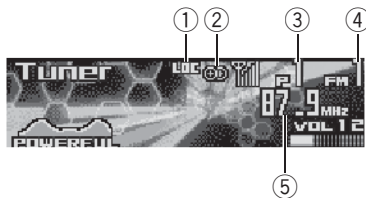

These are the basic steps necessary to operate the radio. More advanced tuner operation is explained starting on the next page.

① **LOC indicator**

Shows when local seek tuning is on.

② **Stereo (Ⓢ) indicator**

Shows that the frequency selected is being broadcast in stereo.

③ **Preset number indicator**

Shows which preset has been selected.

④ **Band indicator**

Shows which band the radio is tuned to, AM or FM.

⑤ **Frequency indicator**

Shows to which frequency the tuner is tuned.

1 **Press SOURCE to select the tuner.**

Press **SOURCE** until you see **Tuner** displayed.

2 **Press BAND/ESC to select a band.**

Press **BAND/ESC** until the desired band is displayed, **FM1**, **FM2**, **FM3** for FM or **AM**.

3 **To perform manual tuning, push MULTI-CONTROL left or right.**

The frequencies move up or down step by step.

4 **To perform seek tuning, push and hold MULTI-CONTROL left or right for about one second and release.**

The tuner will scan the frequencies until a broadcast strong enough for good reception is found.

- You can cancel seek tuning by pushing **MULTI-CONTROL** left or right.
- If you push and hold **MULTI-CONTROL** left or right you can skip stations. Seek tuning starts as soon as you release **MULTI-CONTROL**. 

Introduction of advanced tuner operation



① Function name tag

Shows the function currently selected in highlighted manner.

② Function display

Shows the function status.

1 Press MULTI-CONTROL to display the main menu.

FUNCTION, **AUDIO** and **ENTERTAINMENT** appear on the display.

2 Use MULTI-CONTROL to select FUNCTION.

Turn to change the menu option; press to select.

The function name appears on the display.

3 Turn MULTI-CONTROL to select the function.

Turn **MULTI-CONTROL** clockwise to switch between the functions in the following order:

BSM (best stations memory)—**LOCAL** (local seek tuning)

- You can also switch between the functions in the reverse order by turning **MULTI-CONTROL** counterclockwise.

- To return to the frequency display, press **BAND/ESC**.

Note

If you do not operate the function within about 30 seconds, the display is automatically returned to the frequency display.

Storing and recalling broadcast frequencies

If you press any of the preset tuning buttons **1–6** you can easily store up to six broadcast frequencies for later recall with the touch of a button.

● When you find a frequency that you want to store in memory press one of preset tuning buttons 1–6 and hold until the preset number stops flashing.

The number you have pressed will flash in the preset number indicator and then remain lit. The selected radio station frequency has been stored in memory.

The next time you press the same preset tuning button the radio station frequency is recalled from memory.

Notes

- Up to 18 FM stations, six for each of the three FM bands, and six AM stations can be stored in memory.
- You can also recall radio station frequencies assigned to preset tuning buttons **1–6** by pushing **MULTI-CONTROL** up or down.
- You can also store the radio station frequency in memory by using the preset channel list. (Refer to *Selecting stations from the preset channel list* on the next page.)

Tuning in strong signals

Local seek tuning lets you tune in only those radio stations with sufficiently strong signals for good reception.

1 Use **MULTI-CONTROL** to select **LOCAL**.

The function name tag **LOCAL** is highlighted.

2 Press **MULTI-CONTROL** to turn local seek tuning on.

Local seek sensitivity (e.g., **Local 2**) appears in the display.

- To turn local seek tuning off, press **MULTI-CONTROL** again.

3 Push **MULTI-CONTROL** left or right to set the sensitivity.

There are four levels of sensitivity for FM and two levels for AM:

FM: **Local 1—Local 2—Local 3—Local 4**

AM: **Local 1—Local 2**

The **Local 4** setting allows reception of only the strongest stations, while lower settings let you receive progressively weaker stations. 

Storing the strongest broadcast frequencies

BSM (best stations memory) lets you automatically store the six strongest broadcast frequencies under preset tuning buttons **1–6** and once stored there you can tune in to those frequencies with the touch of a button.

1 Use **MULTI-CONTROL** to select **BSM**.

The function name tag **BSM** is highlighted.

2 Press **MULTI-CONTROL** to turn **BSM** on.

Searching begins to flash. While **Searching** is flashing the six strongest broadcast frequencies will be stored under preset tuning buttons

1–6 in the order of their signal strength. When finished, the preset channel list appears.

- To cancel the storage process, press **MULTI-CONTROL**.

3 Use **MULTI-CONTROL** to select the desired station.

Turn to change the station; press to select.

- You can also change the station by pushing **MULTI-CONTROL** up or down.



Note

Storing broadcast frequencies with BSM may replace broadcast frequencies you have saved using buttons **1–6**. 

Selecting stations from the preset channel list

The preset channel list lets you see the list of preset stations and select one of them to receive.

1 Turn **MULTI-CONTROL** to switch to the preset channel list mode.

2 Use **MULTI-CONTROL** to select the desired station.

Turn to change the station; press to select.

- You can also change the station by pushing **MULTI-CONTROL** up or down.
- To store the currently received frequency in memory, press and hold **MULTI-CONTROL** until the selected preset number stops flashing.
- To return to the frequency display, press **BAND/ESC**. 

Built-in CD Player

Playing a CD

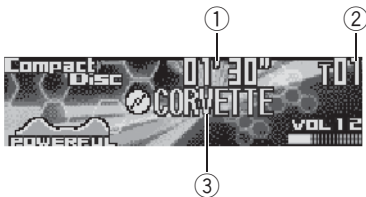

These are the basic steps necessary to play a CD with your built-in CD player. More advanced CD operation is explained starting on the next page.

① Play time indicator

Shows the elapsed playing time of the current track.

② Track number indicator

Shows the track currently playing.

③ Disc title indicator

Shows the title of the currently playing disc.

- If no title has been entered for the currently playing disc, nothing is displayed.

1 Press SOURCE to select the built-in CD player.

Press **SOURCE** until you see **Compact Disc** displayed.

- If no disc is loaded in the unit, you cannot select **Compact Disc** (built-in CD player). Insert a disc in the unit. (Refer to page 13.)

2 To perform fast forward or reverse, push and hold MULTI-CONTROL left or right.

- If you select **ROUGH**, pushing and holding **MULTI-CONTROL** left or right enables you to search every 10 tracks in the current disc. (Refer to *Selecting the search method* on page 21.)

3 To skip back or forward to another track, push MULTI-CONTROL left or right.

Pushing **MULTI-CONTROL** right skips to the start of the next track. Pushing **MULTI-CONTROL** left once skips to the start of the current track. Pushing again will skip to the previous track.



Note

When a disc is inserted, the disc and track titles automatically begin to scroll in the display. When Ever Scroll is set to ON at the initial setting, the disc and track titles scroll continuously. About Ever Scroll, refer to *Switching the Ever Scroll* on page 60. □

Selecting a track directly

When using the remote control, you can select a track directly by entering the desired track number.

1 Press DIRECT.

Track number input display appears.

2 Press 0–9 buttons to enter the desired track number.

- You can cancel the input number by pressing **CLEAR**.

3 Press DIRECT.

The track of entered number will play.



Note

After entering the number input mode, if you do not perform an operation within about eight seconds, the mode is automatically canceled. □

Introduction of advanced built-in CD player operation

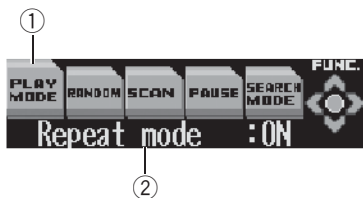

① Function name tag

Shows the function currently selected in highlighted manner.

② Function display

Shows the function status.

1 Press **MULTI-CONTROL** to display the main menu.

FUNCTION, **AUDIO** and **ENTERTAINMENT** appear on the display.

2 Use **MULTI-CONTROL** to select **FUNCTION**.

Turn to change the menu option; press to select.

The function name appears on the display.

3 Turn **MULTI-CONTROL** to select the function.

Turn **MULTI-CONTROL** clockwise to switch between the functions in the following order:

PLAY MODE (repeat play)—**RANDOM** (random play)—**SCAN** (scan play)—**PAUSE** (pause)—**SEARCH MODE** (search method)—**TAG READ** (tag display)—**COMP/BMX** (compression and BMX)—**DISC TITLE** (disc title input)

- You can also switch between the functions in the reverse order by turning **MULTI-CONTROL** counterclockwise.

- To return to the playback display, press **BAND/ESC**.



Notes

- When playing audio data (CD-DA), tag display is not effective even if you turn **TAG READ** (tag display) on. (Refer to page 28.)
- When playing a CD TEXT disc, you cannot switch to **DISC TITLE**. The disc title will have already been recorded on a CD TEXT disc.
- If you do not operate the function within about 30 seconds, the display is automatically returned to the playback display.

Repeating play

Repeat play lets you hear the same track over again.

1 Use **MULTI-CONTROL** to select **PLAY MODE**.

The function name tag **PLAY MODE** is highlighted.

2 Press **MULTI-CONTROL** to turn repeat play on.

Repeat mode:ON appears in the display. The track currently playing will play to the end and then repeat.

- To turn repeat play off, press **MULTI-CONTROL** again.



Note

If you perform track search or fast forward/reverse, repeat play is automatically cancelled.

Built-in CD Player

Playing tracks in a random order

Random play lets you play back tracks on the CD in a random order.

1 Use MULTI-CONTROL to select RANDOM.

The function name tag **RANDOM** is highlighted.

2 Press MULTI-CONTROL to turn random play on.

Random mode :ON appears in the display. Tracks will play in a random order.

- To turn random play off, press **MULTI-CONTROL** again. 

Scanning tracks of a CD

Scan play lets you hear the first 10 seconds of each track on the CD.

1 Use MULTI-CONTROL to select SCAN.
The function name tag **SCAN** is highlighted.

2 Press MULTI-CONTROL to turn scan play on.

Scan mode :ON appears in the display. The first 10 seconds of each track is played.

3 When you find the desired track press MULTI-CONTROL to turn scan play off.

Scan mode :OFF appears in the display. The track will continue to play.

- If the display has automatically returned to the playback display, select **SCAN** again by using **MULTI-CONTROL**.



Note

After scanning of a CD is finished, normal playback of the tracks will begin again. 

Pausing CD playback

Pause lets you temporarily stop playback of the CD.

1 Use MULTI-CONTROL to select PAUSE.
The function name tag **PAUSE** is highlighted.

2 Press MULTI-CONTROL to turn pause on.

Pause :ON appears in the display. Play of the current track pauses.

- To turn pause off, press **MULTI-CONTROL** again. 

Selecting the search method

You can switch the search method between fast forward/reverse and searching every 10 tracks.

1 Use MULTI-CONTROL to select SEARCH MODE.

The function name tag **SEARCH MODE** is highlighted.

2 Press MULTI-CONTROL to select the search method.

Press **MULTI-CONTROL** until the desired search method appears in the display.

- **FF/REV** – Fast forward and reverse
- **ROUGH** – Searching every 10 tracks 

Searching every 10 tracks in the current disc

If a disc contains over 10 tracks, you can search every 10 tracks. When a disc contains a lot of tracks, you can roughly search for the track you want to play.

1 Select the search method ROUGH.

Refer to *Selecting the search method* on this page.

2 Push and hold **MULTI-CONTROL** left or right to search every 10 tracks on a disc.

▪ If a disc contains less than 10 tracks, pushing and holding **MULTI-CONTROL** right recalls the last track of the disc. Also, if the remaining number of tracks after searching every 10 tracks is less than 10, pushing and holding

MULTI-CONTROL right recalls the last track of the disc.

▪ If a disc contains less than 10 tracks, pushing and holding **MULTI-CONTROL** left recalls the first track of the disc. Also, if the remaining number of tracks after searching every 10 tracks is less than 10, pushing and holding **MULTI-CONTROL** left recalls the first track of the disc. 

Using compression and BMX

Using the COMP (compression) and BMX functions let you adjust the sound playback quality of the CD player. Each of the functions have a two-step adjustment. The COMP function balances the output of louder and softer sounds at higher volumes. BMX controls sound reverberations to give playback a fuller sound. Listen to each of the effects as you select through them and use the one that best enhances the playback of the track or CD that you are listening to.

1 Use **MULTI-CONTROL** to select **COMP/BMX**.

The function name tag **COMP/BMX** is highlighted.

2 Press **MULTI-CONTROL** to select your favorite setting.

Press **MULTI-CONTROL** repeatedly to switch between the following settings:

OFF—COMP 1—COMP 2—OFF—BMX 1—BMX 2 

Entering disc titles

You can input CD titles and display the title. The next time you insert a CD for which you

have entered a title, the title of that CD will be displayed.

Use the disc title input feature to store up to 48 CD titles in the unit. Each title can be up to 10 characters long.

- When playing a CD TEXT disc, you cannot switch to **DISC TITLE**. The disc title will have already been recorded on a CD TEXT disc.

1 Play the CD that you want to enter a title for.

2 Use **MULTI-CONTROL** to select **DISC TITLE**.

The function name tag **DISC TITLE** is highlighted.

3 Press button 1 to select the desired character type.

Press button **1** repeatedly to switch between the following character types: Alphabet (upper case), numbers and symbols—Alphabet (lower case)—European letters, such as those with accents (e.g., **á, à, ã, ç**)

- You can select to input numbers and symbols by pressing button **2**.

4 Push **MULTI-CONTROL** up or down to select a letter of the alphabet.

Each pushing **MULTI-CONTROL** up will display a letter of the alphabet in **A B C ... X Y Z**, numbers and symbols in **1 2 3 ... @ # <** order. Each pushing **MULTI-CONTROL** down will display a letter in the reverse order, such as **Z Y X ... C B A**.



5 Push **MULTI-CONTROL** right to move the cursor to the next character position.

When the letter you want is displayed, push **MULTI-CONTROL** right to move the cursor to the next position and then select the next letter. Push **MULTI-CONTROL** left to move backwards in the display.

Built-in CD Player

6 Move the cursor to the last position by pushing MULTI-CONTROL right after entering the title.

When you push **MULTI-CONTROL** right one more time, the entered title is stored in memory.

7 Press BAND/ESC to return to the playback display.



Notes

- Titles remain in memory, even after the disc has been removed from the unit, and are recalled when the disc is reinserted.
- After data for 48 discs has been stored in memory, data for a new disc will overwrite the oldest one.
- If you connect a multi-CD player, you can input disc titles for up to 100 discs.
- When a multi-CD player that does not support disc title functions is connected, you cannot enter disc titles in this unit.

Using CD TEXT functions

Some discs have certain information encoded on the disc during manufacture. These discs may contain such information as the CD title, track title, artist's name and playback time and are called CD TEXT discs. Only these specially encoded CD TEXT discs support the functions listed below.

Displaying titles on CD TEXT discs

● Press DISPLAY.

Press **DISPLAY** repeatedly to switch between the following settings:

: track title—: disc title and : disc artist name—: disc artist name and : track title—: track title and : track artist name—: track artist name and : track title

■ If specific information has not been recorded on a CD TEXT disc, title or name is not displayed.

Scrolling titles in the display

This unit can display the first 14 (22) letters of disc title, disc artist name, track title and track artist name. When the text information is longer than 14 (22) letters, you can scroll the display as follows.

● Press DISPLAY and hold until the title begins to scroll through the display.

The titles scroll.



Note

When Ever Scroll is set to ON at the initial setting, CD text information scrolls continuously in the display. If you want to display the first 14 (22) characters of text information temporarily and scroll from the beginning, press and hold **DISPLAY**. About Ever Scroll, refer to *Switching the Ever Scroll* on page 60.

Selecting tracks from the track title list

Track title list lets you see the list of track titles on a CD TEXT disc and select one of them to play back.

1 Turn MULTI-CONTROL to switch to the track title list mode.

2 Use MULTI-CONTROL to select the desired track title.

Turn to change the track title; press to play.

- You can also change the track title by pushing **MULTI-CONTROL** up or down.
- To return to the playback display, press **BAND/ESC**.

Playing MP3/WMA/WAV

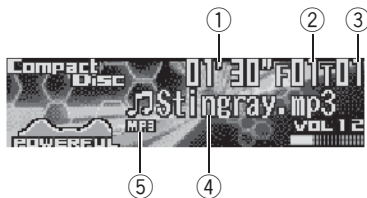

These are the basic steps necessary to play an MP3/WMA/WAV with your built-in CD player. More advanced MP3/WMA/WAV operation is explained starting on page 26.

- ① **Play time indicator**
Shows the elapsed playing time of the current track (file).
- ② **Folder number indicator**
Shows the number of folder currently playing.
- ③ **Track number indicator**
Shows the track (file) currently playing.
- ④ **File name indicator**
Shows the name of file currently playing.
- ⑤ **MP3/WMA/WAV indicator**
Shows the type of file currently playing.

1 Press SOURCE to select the built-in CD player.

Press **SOURCE** until you see **Compact Disc** displayed.

- If no disc is loaded in the unit, you cannot select **Compact Disc** (built-in CD player). Insert a disc in the unit. (Refer to page 13.)

2 Push MULTI-CONTROL up or down to select a folder.

- You cannot select a folder that does not have an MP3/WMA/WAV file recorded in it.

- To return to folder 01 (ROOT), press and hold **BAND/ESC**. However, if folder 01 (ROOT) contains no files, playback commences with folder 02.

3 To perform fast forward or reverse, push and hold MULTI-CONTROL left or right.

- This is fast forward and reverse operation only for the file being played. This operation is canceled when the previous or next file is reached.
- If you select **ROUGH**, pushing and holding **MULTI-CONTROL** left or right enables you to search every 10 tracks in the current folder. (Refer to *Selecting the search method* on page 27.)

4 To skip back or forward to another track, push MULTI-CONTROL left or right.

Pushing **MULTI-CONTROL** right skips to the start of the next track. Pushing **MULTI-CONTROL** left once skips to the start of the current track. Pushing again will skip to the previous track.



Notes

- When playing discs with MP3/WMA/WAV files and audio data (CD-DA) such as CD-EXTRA and MIXED-MODE CDs, both types can be played only by switching mode between MP3/WMA/WAV and CD-DA with **BAND/ESC**.
- If you have switched between playback of MP3/WMA/WAV files and audio data (CD-DA), playback starts at the first track on the disc.
- The built-in CD player can play back an MP3/WMA/WAV file recorded on CD-ROM. (Refer to page 67 for files that can be played back.)
- There is sometimes a delay between starting up CD playback and the sound being issued. When being read in, **Format read** is displayed.
- Playback is carried out in order of file number. Folders are skipped if they contain no files. (If folder 01 (ROOT) contains no files, playback commences with folder 02.)

MP3/WMA/WAV Player

- When playing back files recorded as VBR (variable bit rate) files, the play time will not be correctly displayed if fast forward or reverse operations are used.
- If the inserted disc contains no files that can be played back, **No audio** is displayed.
- If the inserted disc contains WMA files that are protected by digital rights management (DRM), **Track skipped** is displayed while the protected file is skipped.
- If all the files on the inserted disc are secured by DRM, **Protect** is displayed.
- There is no sound on fast forward or reverse.
- When an MP3/WMA/WAV disc is inserted, folder name and file name automatically begin to scroll in the display. When Ever Scroll is set to ON at the initial setting, folder and file name scroll continuously. About Ever Scroll, refer to *Switching the Ever Scroll* on page 60. 



Note

After entering the number input mode, if you do not perform an operation within about eight seconds, the mode is automatically canceled. 

Selecting a track directly in the current folder

When using the remote control, you can select a track directly by entering the desired track number.

1 Press DIRECT.

Track number input display appears.

2 Press 0–9 buttons to enter the desired track number.

- You can cancel the input number by pressing **CLEAR**.

3 Press DIRECT.

The track of entered number will play.

Introduction of advanced built-in CD player (MP3/WMA/WAV) operation

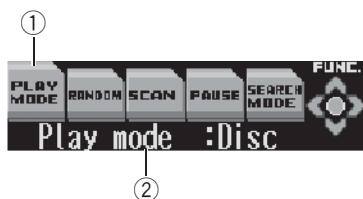

① Function name tag

Shows the function currently selected in highlighted manner.

② Function display

Shows the function status.

1 Press MULTI-CONTROL to display the main menu.

FUNCTION, AUDIO and **ENTERTAINMENT** appear on the display.

2 Use MULTI-CONTROL to select FUNCTION.

Turn to change the menu option; press to select.

The function name appears on the display.

3 Turn MULTI-CONTROL to select the function.

Turn **MULTI-CONTROL** clockwise to switch between the functions in the following order:

PLAY MODE (repeat play)—**RANDOM** (random play)—**SCAN** (scan play)—**PAUSE** (pause)—**SEARCH MODE** (search method)—**TAG READ** (tag display)—**COMP/BMX** (compression and BMX)

- You can also switch between the functions in the reverse order by turning **MULTI-CONTROL** counterclockwise.

- To return to the playback display, press **BAND/ESC**.



Note

If you do not operate the function within about 30 seconds, the display is automatically returned to the playback display.

Repeating play

For MP3/WMA/WAV playback, there are three repeat play ranges: **Folder** (folder repeat), **Track** (one-track repeat) and **Disc** (repeat all tracks).

1 Use MULTI-CONTROL to select PLAY MODE.

The function name tag **PLAY MODE** is highlighted.

2 Press MULTI-CONTROL to select the repeat range.

Press **MULTI-CONTROL** repeatedly until the desired repeat range appears in the display.

- **Folder** – Repeat the current folder
- **Track** – Repeat just the current track
- **Disc** – Repeat all tracks



Notes

- If you select another folder during repeat play, the repeat play range changes to **Disc**.
- If you perform track search or fast forward/reverse during **Track**, the repeat play range changes to **Folder**.
- When **Folder** is selected, it is not possible to play back a subfolder of that folder.

MP3/WMA/WAV Player

Playing tracks in a random order

Random play lets you play back tracks in a random order within the repeat range, **Folder** and **Disc**.

1 Select the repeat range.

Refer to *Repeating play* on the previous page.

2 Use MULTI-CONTROL to select **RANDOM**.

The function name tag **RANDOM** is highlighted.

3 Press MULTI-CONTROL to turn random play on.

Random mode :ON appears in the display. Tracks will play in a random order within the previously selected **Folder** or **Disc** ranges.

- To turn random play off, press **MULTI-CONTROL** again. 

Scanning folders and tracks

While you are using **Folder**, the beginning of each track in the selected folder plays for about 10 seconds. When you are using **Disc**, the beginning of the first track of each folder is played for about 10 seconds.

1 Select the repeat range.

Refer to *Repeating play* on the previous page.

2 Use MULTI-CONTROL to select **SCAN**.

The function name tag **SCAN** is highlighted.

3 Press MULTI-CONTROL to turn scan play on.

Scan mode :ON appears in the display. The first 10 seconds of each track of the current folder (or the first track of each folder) is played.

4 When you find the desired track (or folder) press MULTI-CONTROL to turn scan play off.

Scan mode :OFF appears in the display. The track (or folder) will continue to play.

- If the display has automatically returned to the playback display, select **SCAN** again by using **MULTI-CONTROL**.



Note

After track or folder scanning is finished, normal playback of the tracks will begin again. 

Pausing MP3/WMA/WAV playback

Pause lets you temporarily stop playback of the MP3/WMA/WAV.

1 Use MULTI-CONTROL to select **PAUSE**.

The function name tag **PAUSE** is highlighted.

2 Press MULTI-CONTROL to turn pause on.

Pause :ON appears in the display. Play of the current track pauses.

- To turn pause off, press **MULTI-CONTROL** again. 

Selecting the search method

You can switch the search method between fast forward/reverse and searching every 10 tracks.

1 Use MULTI-CONTROL to select **SEARCH MODE**.

The function name tag **SEARCH MODE** is highlighted.

2 Press **MULTI-CONTROL** to select the search method.

Press **MULTI-CONTROL** until the desired search method appears in the display.

- **FF/REV** – Fast forward and reverse
- **ROUGH** – Searching every 10 tracks 

Searching every 10 tracks in the current folder

If the current folder contains over 10 tracks, you can search every 10 tracks. When one folder contains a lot of tracks, you can roughly search for the track you want to play.

1 Select the search method **ROUGH**.

Refer to *Selecting the search method* on the previous page.

2 Push and hold **MULTI-CONTROL** left or right to search every 10 tracks in the current folder.

- If the current folder contains less than 10 tracks, pushing and holding **MULTI-CONTROL** right recalls the last track of the folder. Also, if the remaining number of tracks after searching every 10 tracks is less than 10, pushing and holding **MULTI-CONTROL** right recalls the last track of the folder.
- If the current folder contains less than 10 tracks, pushing and holding **MULTI-CONTROL** left recalls the first track of the folder. Also, if the remaining number of tracks after searching every 10 tracks is less than 10, pushing and holding **MULTI-CONTROL** left recalls the first track of the folder. 

Switching the tag display

It is possible to turn the tag display on or off, if MP3/WMA disc contains text information such as track title and artist name.

- If you turn the tag display off, time to playback will be shorter than when this function is turned on.

1 Use **MULTI-CONTROL** to select **TAG READ**.

The function name tag **TAG READ** is highlighted.

2 Press **MULTI-CONTROL** to turn tag display on.

Tag read mode :ON appears in the display.

- To turn tag display off, press **MULTI-CONTROL** again.



Note

When you turn the tag display on, the unit returns to the beginning of the current track in order to read the text information. 

Using compression and **BMX**

Using the **COMP** (compression) and **BMX** functions let you adjust the sound playback quality of the CD player. Each of the functions have a two-step adjustment. The **COMP** function balances the output of louder and softer sounds at higher volumes. **BMX** controls sound reverberations to give playback a fuller sound. Listen to each of the effects as you select through them and use the one that best enhances the playback of the track or CD that you are listening to.

1 Use **MULTI-CONTROL** to select **COMP/BMX**.

The function name tag **COMP/BMX** is highlighted.

MP3/WMA/WAV Player

2 Press MULTI-CONTROL to select your favorite setting.

Press **MULTI-CONTROL** repeatedly to switch between the following settings:

OFF—COMP 1—COMP 2—OFF—BMX 1—BMX 2 











Displaying text information on MP3/WMA/WAV disc

Text information recorded on an MP3/WMA/WAV disc can be displayed.

When playing back an MP3/WMA disc

● Press DISPLAY.

Press **DISPLAY** repeatedly to switch between the following settings:

: file name—: folder name and : file name—: album title and : track title—: track title and : artist name—: artist name and : comment—: comment and bit rate

- When playing back MP3 files recorded as VBR (variable bit rate) files, the bit rate value is not displayed even after switching to bit rate. (VBR will be displayed.)

- When playing back WMA files recorded as VBR (variable bit rate) files, the average bit rate value is displayed.

- When you have turned tag display off, you cannot switch to track title, artist name, album title or comment.



- If specific information has not been recorded on an MP3/WMA disc, title or name is not displayed.

- With some applications used to encode WMA files, album names and other text information may not be correctly displayed.

When playing back a WAV disc

● Press DISPLAY.

Press **DISPLAY** repeatedly to switch between the following settings:

: file name—: folder name and : file name—sampling frequency

- You can only play back WAV files in the frequencies 16, 22.05, 24, 32, 44.1 and 48 kHz (LPCM), or 22.05 and 44.1 kHz (MS ADPCM). The sampling frequency shown in the display may be rounded. 

Scrolling text information in the display

This unit can display the first 14 (22) letters only of folder name, file name, track title, artist name, album title and comment. When the recorded information is longer than 14 (22) letters, you can scroll the text to the left so that the rest of the text information can be seen.

● Press DISPLAY and hold until the text information begins to scroll through the display.

The text information scrolls.



Notes

- Unlike MP3 and WMA file format, WAV files display only folder name and file name.
- When Ever Scroll is set to ON at the initial setting, CD text information scrolls continuously in the display. If you want to display the first 14 (22) characters of text information temporarily and scroll from the beginning, press and hold **DISPLAY**. About Ever Scroll, refer to *Switching the Ever Scroll* on page 60. 

Selecting tracks from the file name list

File name list lets you see the list of file names (or folder names) and select one of them to playback.

1 Turn **MULTI-CONTROL** to switch to the file name list mode.

Names of files and folders appear in the display.

2 Use **MULTI-CONTROL** to select the desired file name (or folder name).

Turn to change the name of file or folder; press to play; push right to see a list of the files (or folders) in the selected folder.

- You can also change the name of file or folder by pushing **MULTI-CONTROL** up or down.
- To return to the previous list (the folder one level higher), push **MULTI-CONTROL** left.
- To return to the playback display, press

BAND/ESC. 

Multi-CD Player

Playing a CD

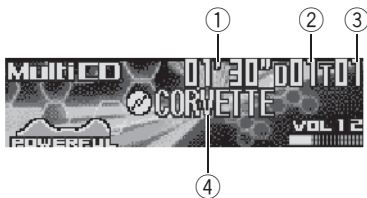

You can use this unit to control a multi-CD player, which is sold separately.

These are the basic steps necessary to play a CD with your multi-CD player. More advanced CD operation is explained starting on the next page.

① Play time indicator

Shows the elapsed playing time of the current track.

② Disc number indicator

Shows the disc currently playing.

③ Track number indicator

Shows the track currently playing.

④ Disc title indicator

Shows the title of the currently playing disc.

- If no title has been entered for the currently playing disc, nothing is displayed.

1 Press SOURCE to select the multi-CD player.

Press **SOURCE** until you see **Multi CD** displayed.

2 Select a disc you want to listen to with the 1–6 buttons.

For discs located at 1 to 6, press the corresponding button number.

If you want to select a disc located at 7 to 12, press and hold the corresponding numbers,

such as **1** for disc 7, until the disc number appears in the display.

- You can also sequentially select a disc by pushing **MULTI-CONTROL** up or down.

3 To perform fast forward or reverse, push and hold MULTI-CONTROL left or right.

4 To skip back or forward to another track, push MULTI-CONTROL left or right.

Pushing **MULTI-CONTROL** right skips to the start of the next track. Pushing

MULTI-CONTROL left once skips to the start of the current track. Pushing again will skip to the previous track.



Notes

- When the multi-CD player performs the preparatory operations, **Ready** is displayed.
- If the multi-CD player does not operate properly, an error message such as **ERROR-11** may be displayed. Refer to the multi-CD player owner's manual.
- If there are no discs in the multi-CD player magazine, **No disc** is displayed.
- When you select a disc, the disc and track titles automatically begin to scroll in the display. When Ever Scroll function is ON at the initial setting, the disc and track titles scroll continuously. About Ever Scroll, refer to *Switching the Ever Scroll* on page 60. □

Selecting a track directly

When using the remote control, you can select a track directly by entering the desired track number.

1 Press DIRECT.

Track number input display appears.

2 Press 0–9 buttons to enter the desired track number.

- You can cancel the input number by pressing **CLEAR**.

3 Press DIRECT.

The track of entered number will play.



Note

After entering the number input mode, if you do not perform an operation within about eight seconds, the mode is automatically canceled. □

50-disc multi-CD player

Only those functions described in this manual are supported for 50-disc multi-CD players.

This unit is not designed to operate disc title list functions with a 50-disc multi-CD player.

About the disc title list functions, please refer to *Selecting discs from the disc title list* on page 36. □

Introduction of advanced multi-CD player operation

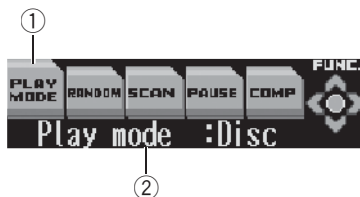

① Function name tag

Shows the function currently selected in highlighted manner.

② Function display

Shows the function status.

1 Press MULTI-CONTROL to display the main menu.
FUNCTION, AUDIO and **ENTERTAINMENT** appear on the display.

2 Use MULTI-CONTROL to select FUNCTION.

Turn to change the menu option; press to select.

The function name appears on the display.

3 Turn MULTI-CONTROL to select the function.

Turn **MULTI-CONTROL** clockwise to switch between the functions in the following order:

PLAY MODE (repeat play)—**RANDOM** (random play)—**SCAN** (scan play)—**PAUSE** (pause)—**COMP** (compression and DBE)—**ITS PLAY** (ITS play)—**ITS MEMORY** (ITS programming)—**D.TITLE INPUT** (disc title input)

- You can also switch between the functions in the reverse order by turning **MULTI-CONTROL** counterclockwise.
- To return to the playback display, press **BAND/ESC**.

Multi-CD Player



Notes

- When playing a CD TEXT disc on a CD TEXT compatible multi-CD player, you cannot switch to **D.TITLE INPUT**. The disc title will have already been recorded on a CD TEXT disc.
- If you do not operate the function within about 30 seconds, the display is automatically returned to the playback display.

Repeating play

There are three repeat play ranges for the multi-CD player: **MCD** (multi-CD player repeat), **Track** (one-track repeat) and **Disc** (disc repeat).

1 Use MULTI-CONTROL to select PLAY MODE.

The function name tag **PLAY MODE** is highlighted.

2 Press MULTI-CONTROL to select the repeat range.

Press **MULTI-CONTROL** repeatedly until the desired repeat range appears in the display.

- **MCD** – Repeat all discs in the multi-CD player
- **Track** – Repeat just the current track
- **Disc** – Repeat the current disc



Notes

- If you select other discs during repeat play, the repeat play range changes to **MCD**.
- If you perform track search or fast forward/reverse during **Track**, the repeat play range changes to **Disc**.

Playing tracks in a random order

Random play lets you play back tracks in a random order within the repeat range, **MCD** and **Disc**.

1 Select the repeat range.

Refer to *Repeating play* on this page.

2 Use MULTI-CONTROL to select RANDOM.

The function name tag **RANDOM** is highlighted.

3 Press MULTI-CONTROL to turn random play on.

Random mode :ON appears in the display.

Tracks will play in a random order within the previously selected **MCD** or **Disc** ranges.

- To turn random play off, press **MULTI-CONTROL** again.

Scanning CDs and tracks

While you are using **Disc**, the beginning of each track on the selected disc plays for about 10 seconds. When you are using **MCD**, the beginning of the first track of each disc is played for about 10 seconds.

1 Select the repeat range.

Refer to *Repeating play* on this page.

2 Use MULTI-CONTROL to select SCAN.

The function name tag **SCAN** is highlighted.

3 Press MULTI-CONTROL to turn scan play on.

Scan mode :ON appears in the display. The first 10 seconds of each track of the current disc (or the first track of each disc) is played.

4 When you find the desired track (or disc) press **MULTI-CONTROL** to turn scan play off.

Scan mode:OFF appears in the display. The track (or disc) will continue to play.

- If the display has automatically returned to the playback display, select **SCAN** again by using **MULTI-CONTROL**.



Note

After track or disc scanning is finished, normal playback of the tracks will begin again. 

Pausing CD playback

Pause lets you temporarily stop playback of the CD.

1 Use MULTI-CONTROL to select PAUSE.
The function name tag **PAUSE** is highlighted.

2 Press MULTI-CONTROL to turn pause on.

Pause:ON appears in the display. Play of the current track pauses.

- To turn pause off, press **MULTI-CONTROL** again. 

Using ITS playlists

ITS (instant track selection) lets you make a playlist of favorite tracks from those in the multi-CD player magazine. After you have added your favorite tracks to the playlist you can turn on ITS play and play just those selections.

Creating a playlist with ITS programming

You can use ITS to enter and play back up to 99 tracks per disc, up to 100 discs (with the disc titles). (With multi-CD players sold before the CDX-P1250 and CDX-P650, up to 24 tracks can be stored in the playlist.)

1 Play a CD that you want to program.

Push **MULTI-CONTROL** up or down to select the CD.

2 Use MULTI-CONTROL to select ITS MEMORY.

The function name tag **ITS MEMORY** is highlighted.

3 Select the desired track by pushing MULTI-CONTROL left or right.

4 Push MULTI-CONTROL up to store the currently playing track in the playlist.

Memory complete is displayed briefly and the currently playing selection is added to your playlist. The display then shows **ITS memory** again.

5 Press BAND/ESC to return to the playback display.



Note

After data for 100 discs has been stored in memory, data for a new disc will overwrite the oldest one.

Playback from your ITS playlist

ITS play lets you listen to the tracks that you have entered into your ITS playlist. When you turn on ITS play, tracks from your ITS playlist in the multi-CD player will begin to play.

Multi-CD Player

1 Select the repeat range.

Refer to *Repeating play* on page 33.

2 Use MULTI-CONTROL to select ITS PLAY.

The function name tag **ITS PLAY** is highlighted.

3 Press MULTI-CONTROL to turn ITS play on.

ITS play mode:ON appears in the display. Playback begins of those tracks from your playlist within the previously selected **MCD** or **Disc** ranges.

- If no tracks in the current range are programmed for ITS play then **Memory empty** is displayed.
- To turn ITS play off, press **MULTI-CONTROL** again.

Erasing a track from your ITS playlist

When you want to delete a track from your ITS playlist, you can if ITS play is on.

If ITS play is already on, skip to step 2. If ITS play is not already on, use **MULTI-CONTROL**.

1 Play the CD with the track you want to delete from your ITS playlist, and turn ITS play on.

Refer to *Playback from your ITS playlist* on the previous page.

2 Use MULTI-CONTROL to select ITS MEMORY.

The function name tag **ITS MEMORY** is highlighted.

3 Select the desired track by pushing MULTI-CONTROL left or right.

4 Push MULTI-CONTROL down to erase the track from your ITS playlist.

The currently playing selection is erased from your ITS playlist and playback of the next track from your ITS playlist begins.

- If there are no tracks from your playlist in the current range, **Memory deleted** is displayed and normal play resumes.

5 Press BAND/ESC to return to the playback display.

Erasing a CD from your ITS playlist

When you want to delete all tracks of a CD from your ITS playlist, you can if ITS play is off.

1 Play the CD that you want to delete.

Push **MULTI-CONTROL** up or down to select the CD.

2 Use MULTI-CONTROL to select ITS MEMORY.

The function name tag **ITS MEMORY** is highlighted.

3 Push MULTI-CONTROL down to erase all tracks on the currently playing CD from your ITS playlist.

All tracks on the currently playing CD are erased from your playlist and **Memory deleted** is displayed.

4 Press BAND/ESC to return to the playback display.

Using disc title functions

You can input CD titles and display the titles. Then you can easily search for and play a desired disc.

Entering disc titles

Use the disc title input feature to store up to 100 CD titles (with ITS playlist) into the multi-CD player. Each title can be up to 10 characters long.

1 Play the CD that you want to enter a title for.

Push **MULTI-CONTROL** up or down to select the CD.

2 Use **MULTI-CONTROL** to select **D.TITLE INPUT**.

The function name tag **D.TITLE INPUT** is highlighted.

- When playing a CD TEXT disc on a CD TEXT compatible multi-CD player, you cannot switch to **D.TITLE INPUT**. The disc title will have already been recorded on a CD TEXT disc.

3 Press button **1** to select the desired character type.

Press button **1** repeatedly to switch between the following character types:
 Alphabet (upper case), numbers and symbols—Alphabet (lower case)—European letters, such as those with accents (e.g., **á, à, ä, ç**)

- You can select to input numbers and symbols by pressing button **2**.

4 Push **MULTI-CONTROL** up or down to select a letter of the alphabet.

Each pushing **MULTI-CONTROL** up will display a letter of the alphabet in **A B C ... X Y Z**, numbers and symbols in **1 2 3 ... @ # <** order. Each pushing **MULTI-CONTROL** down will display a letter in the reverse order, such as **Z Y X ... C B A**.



5 Push **MULTI-CONTROL** right to move the cursor to the next character position.

When the letter you want is displayed, push **MULTI-CONTROL** right to move the cursor to the next position and then select the next letter. Push **MULTI-CONTROL** left to move backwards in the display.

6 Move the cursor to the last position by pushing **MULTI-CONTROL** right after entering the title.

When you push **MULTI-CONTROL** right one more time, the entered title is stored in memory.

7 Press **BAND/ESC** to return to the playback display.



Notes

- Titles remain in memory, even after the disc has been removed from the magazine, and are recalled when the disc is reinserted.
- After data for 100 discs has been stored in memory, data for a new disc will overwrite the oldest one.

Selecting discs from the disc title list

Disc title list lets you see the list of disc titles that have been entered into the multi-CD player and select one of them to play back.

1 Turn **MULTI-CONTROL** to switch to the disc title list mode.

2 Use **MULTI-CONTROL** to select the desired disc title.

Turn to change the disc title; press to play.

- You can also change the disc title by pushing **MULTI-CONTROL** up or down.
- If no title has been entered for a disc, **No title** will be displayed.

Multi-CD Player

- **No disc** is displayed next to the disc number when there is no disc in the magazine.
- To return to the playback display, press **BAND/ESC**. 

Using CD TEXT functions









You can use these functions only with a CD TEXT compatible multi-CD player.

Some discs have certain information encoded on the disc during manufacture. These discs may contain such information as the CD title, track title, artist's name and playback time and are called CD TEXT discs. Only these specially encoded CD TEXT discs support the functions listed below.

Displaying titles on CD TEXT discs

● Press **DISPLAY**.

Press **DISPLAY** repeatedly to switch between the following settings:

: track title—: disc title and : disc artist name—: disc artist name and : track title—: track title and : track artist name—: track artist name and : track title

- If specific information has not been recorded on a CD TEXT disc, title or name is not displayed.

Scrolling titles in the display

This unit can display the first 14 (22) letters of disc title, disc artist name, track title and track artist name. When the text information is longer than 14 (22) letters, you can scroll the display as follows.

● Press **DISPLAY** and hold until the title begins to scroll through the display.

The titles scroll.



Note

When Ever Scroll is set to ON at the initial setting, CD text information scrolls continuously in the display. If you want to display the first 14 (22) characters of text information temporarily and scroll from the beginning, press and hold **DISPLAY**. About Ever Scroll, refer to *Switching the Ever Scroll* on page 60.

Selecting tracks from the track title list

Track title list lets you see the list of track titles on a CD TEXT disc and select one of them to play back.

1 Turn **MULTI-CONTROL** to switch to the disc title list mode.

2 Use **MULTI-CONTROL** to select the desired disc title of CD TEXT.

Turn to change the disc title; press to play.

- You can also change the disc title by pushing **MULTI-CONTROL** up or down.
- If no title has been entered for a disc, **No title** will be displayed.
- **No disc** is displayed next to the disc number when there is no disc in the magazine.

3 Push **MULTI-CONTROL** right to switch to the track title list.

4 Use **MULTI-CONTROL** to select the desired track title.

Turn to change the track title; press to play.

- You can also change the track title by pushing **MULTI-CONTROL** up or down.
- To return to the playback display, press **BAND/ESC**. 

Using compression and bass emphasis

You can use these functions only with a multi-CD player that supports them.

Using COMP (compression) and DBE (dynamic bass emphasis) functions lets you adjust the sound playback quality of the multi-CD player. Each of the functions has a two-step adjustment. The COMP function balances the output of louder and softer sounds at higher volumes. DBE boosts bass levels to give playback a fuller sound. Listen to each of the effects as you select them and use the one that best enhances the playback of the track or CD that you are listening to.

1 Use MULTI-CONTROL to select COMP.

The function name tag **COMP** is highlighted.

- If the multi-CD player does not support COMP/DBE, **No COMP** is displayed when you attempt to select it.

2 Press MULTI-CONTROL to select your favorite setting.

Press **MULTI-CONTROL** repeatedly to switch between the following settings:

OFF—COMP 1—COMP 2—OFF—DBE 1—DBE 2 

XM tuner

Listening to the XM

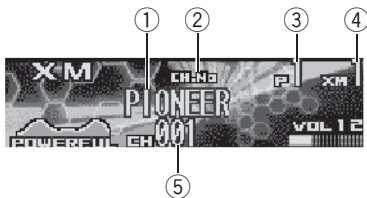

You can use this unit to control a XM satellite digital tuner (GEX-P910XM), which is sold separately.

For details concerning operation, refer to the XM tuner's operation manuals. This section provides information on XM operations with this unit which differs from that described in the XM tuner's operation manual.

- This unit does not have the text scroll function.
- With this unit, you can operate one additional function: XM channel direct selection.

① XM channel name

Shows the channel name of broadcast channel.

② XM channel select setting indicator

Shows what channel select setting has been selected. **CH.No** is displayed when **Channel Number** is selected, and **CATEGORY** is displayed when **Category** is selected.

③ XM preset number indicator

Shows what XM preset has been selected.

④ XM band indicator

Shows the XM band which has been selected.

⑤ XM channel number indicator

Shows to which XM channel number the tuner is tuned.

1 Press SOURCE to select the XM.

Press **SOURCE** until you see **XM** displayed.

2 Press BAND/ESC to select a XM band.

Press **BAND/ESC** repeatedly until the desired XM band is displayed, **XM1**, **XM2** or **XM3**.

3 To perform tuning, push MULTI-CONTROL left or right.

The channels move up or down step by step. Channels that cannot currently be selected are skipped, and the next channel is selected.

- If you push and hold **MULTI-CONTROL** left or right, you can increase or decrease channel number continuously.
- You can also perform tuning from a desired channel category. (Refer to *Selecting the channel in the channel category* on page 41.)

Introduction of advanced XM tuner operation

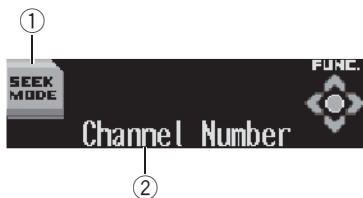

① Function name tag

Shows the function currently selected in highlighted manner.

② Function display

Shows the function status.

1 Press MULTI-CONTROL to display the main menu.

FUNCTION, **AUDIO** and **ENTERTAINMENT** appear on the display.

2 Use MULTI-CONTROL to select FUNCTION.

Turn to change the menu option; press to select.

SEEK MODE appears on the display.

- To return to the channel display, press **BAND/ESC**.



Note

If you do not operate the function within about 30 seconds, the display is automatically returned to the channel display. 

Switching the XM display

● Press DISPLAY to switch the XM display.

Each press of **DISPLAY** changes the XM display in the following order:

Channel name—Artist name/feature—Song/program title—Channel category 

Storing and recalling broadcast stations

If you press any of the preset tuning buttons **1–6** you can easily store up to six broadcast stations for later recall with the touch of a button.

● When you find a station that you want to store in memory press one of preset tuning buttons **1–6** and hold until the XM preset number stops flashing.

The number you have pressed will flash in the XM preset number indicator and then remain lit. The selected station has been stored in memory.

The next time you press the same preset tuning button the station is recalled from memory.



Notes

- Up to 18 stations, six for each of three XM bands can be stored in memory.
- You can also recall stations assigned to preset tuning buttons **1–6** by pushing **MULTI-CONTROL** up or down. 

Switching the XM channel select setting

You can switch if you select a channel with a channel number or from a channel category when you select a channel.

● Press CLOCK and hold to switch the channel select setting.

Press **CLOCK** and hold repeatedly to switch between the following channel select settings: **Channel Number** (channel number select setting)—**Category** (channel category select setting)

- You can also switch the XM channel select setting in the menu that appears by using **MULTI-CONTROL**.

XM tuner

Selecting the channel in the channel category

1 Press CLOCK and hold to select Category.

Press **CLOCK** and hold repeatedly to switch between the following channel select settings:

Channel Number (channel number select setting)—**Category** (channel category select setting)

- You can also switch the XM channel select setting in the menu that appears by using **MULTI-CONTROL**.

2 Push MULTI-CONTROL up or down to select the desired channel category.

3 Push MULTI-CONTROL left or right to select the desired channel in the selected channel category.

Selecting the XM channel directly

When using the remote control, you can select the XM channel directly by entering the desired channel number.

1 Press DIRECT.

Channel number input display appears.

2 Press 0–9 buttons to enter the desired channel number.

- You can cancel the input number by pressing **CLEAR**.

3 Press DIRECT.

The entered XM channel is selected.



Note

After entering the number input mode, if you do not perform an operation within about eight seconds, the mode is automatically canceled. 

Display the ID code

Channel number select setting

If you select **CH000**, the ID code is displayed.

- Push **MULTI-CONTROL** left or right to select **CH000**.

Channel category select setting

RADIO ID is provided as a channel category for displaying the ID code.

- Push **MULTI-CONTROL** up or down to select **RADIO ID** from channel category.
 - If you select another channel, display of the ID code is canceled.
 - Display of the ID code repeats displaying **RADIO ID** and the ID code one after the other. 

Watching the TV tuner

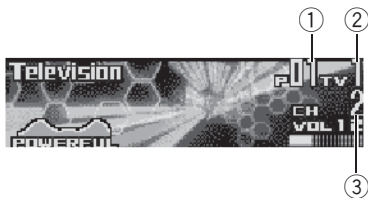

You can use this unit to control a TV tuner, which is sold separately.

For details concerning operation, refer to the TV tuner's operation manuals. This section provides information on TV operations with this unit which differs from that described in the TV tuner's operation manual.

- ① **Preset number indicator**
Shows which preset has been selected.
- ② **Band indicator**
Shows which band the TV tuner is tuned to.
- ③ **Channel indicator**
Shows which channel the TV tuner is tuned to.

1 Press SOURCE to select the TV.

Press **SOURCE** until you see **Television** displayed.

2 Press BAND/ESC to select a band.

Press **BAND/ESC** until the desired band is displayed, **TV1** or **TV2**.

3 To perform manual tuning, push MULTI-CONTROL left or right.

The channels move up or down step by step.

4 To perform seek tuning, push and hold MULTI-CONTROL left or right for about one second and release.

The tuner will scan the channels until a broadcast strong enough for good reception is found.

- You can cancel seek tuning by pushing **MULTI-CONTROL** left or right.
- If you push and hold **MULTI-CONTROL** left or right you can skip broadcasting channels. Seek tuning starts as soon as you release **MULTI-CONTROL**. 

Storing and recalling broadcast stations

If you press any of the preset tuning buttons **1–6** you can easily store up to six broadcast stations for later recall with the touch of a button.

● When you find a station that you want to store in memory press one of preset tuning buttons 1–6 and hold until the preset number stops flashing.

The number you have pressed will flash in the preset number indicator and then remain lit. The selected station has been stored in memory.

The next time you press the same preset tuning button the station is recalled from memory.



Notes

- Up to 12 stations, six for each of two TV bands can be stored in memory.
- You can recall preset channels **P01—P12** by pushing **MULTI-CONTROL** up or down.
- You can also store the station in memory by using the preset channel list. (Refer to *Selecting stations from the preset channel list* on the next page.) 

Storing the strongest broadcast stations sequentially

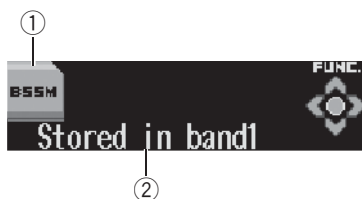

① Function name tag

Shows the function currently selected in highlighted manner.

② Function display

Shows the function status.

1 Press **MULTI-CONTROL** to display the main menu.

FUNCTION, **AUDIO** and **ENTERTAINMENT** appear on the display.

2 Use **MULTI-CONTROL** to select **FUNCTION**.

Turn to change the menu option; press to select.

The function name tag **BSSM** is highlighted.

3 Press **MULTI-CONTROL** to turn **BSSM** on.

Searching begins to flash. While **Searching** is flashing the 12 strongest broadcast stations will be stored in order from the lowest channel up. When finished, the preset channel list appears.

- To cancel the storage process, press

MULTI-CONTROL.

4 Use **MULTI-CONTROL** to select the desired station.

Turn to change the station; press to select.

- You can also change the station by pushing **MULTI-CONTROL** up or down.

- To return to the channel display, press **BAND/ESC**.



Notes

- Storing broadcast stations with BSSM may replace broadcast stations you have saved using **P01—P12**.
- If you do not operate the function within about 30 seconds, the display is automatically returned to the TV picture. 

Selecting stations from the preset channel list

The preset channel list lets you see the list of preset stations and select one of them to receive.

1 Turn **MULTI-CONTROL** to switch to the preset channel list mode.

2 Use **MULTI-CONTROL** to select the desired station.

Turn to change the station; press to select.

- You can also change the station by pushing **MULTI-CONTROL** up or down.

- To store the currently received station in memory, press and hold **MULTI-CONTROL** until the selected preset number stops flashing.

- To return to the channel display, press **BAND/ESC**. 

Playing a disc

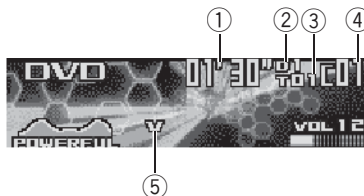

You can use this unit to control a DVD player or multi-DVD player, which is sold separately.

For details concerning operation, refer to the DVD player's or multi-DVD player's operation manual. This section provides information on DVD operations with this unit which differs from that described in the DVD player's or multi-DVD player's operation manual.

① Play time indicator

Shows the elapsed playing time of the current chapter/track.

② Disc number indicator

Shows the disc currently playing when using a multi-DVD player.

③ Title number indicator

Shows the title currently playing during DVD video playback.

④ Chapter/track number indicator

Shows the chapter/track currently playing.

⑤ V/VCD/CD indicator

Shows the type of disc currently playing.

1 Press SOURCE to select the DVD player/multi-DVD player.

Press SOURCE until you see DVD displayed.

2 To perform fast forward or reverse, push and hold MULTI-CONTROL left or right.

3 To skip back or forward to another chapter/track, push MULTI-CONTROL left or right.

Selecting a disc

- You can operate this function only when a multi-DVD player is connected to this unit.
- Press any of 1–6 to select the desired disc.
 - You can also sequentially select a disc by pushing MULTI-CONTROL up or down. 

Introduction of advanced DVD player operation

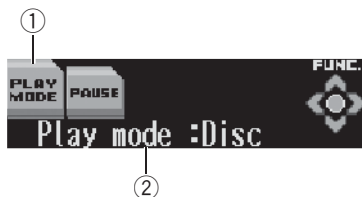

① Function name tag

Shows the function currently selected in highlighted manner.

② Function display

Shows the function status.

1 Press **MULTI-CONTROL** to display the main menu.

FUNCTION, **AUDIO** and **ENTERTAINMENT** appear on the display.

2 Use **MULTI-CONTROL** to select **FUNCTION**.

Turn to change the menu option; press to select.

The function name appears on the display.

3 Turn **MULTI-CONTROL** to select the function.

Turn **MULTI-CONTROL** clockwise to switch between the functions in the following order:

During DVD video or Video CD playback
PLAY MODE (repeat play)—**PAUSE** (pause)

During CD playback

PLAY MODE (repeat play)—**RANDOM** (random play)—**SCAN** (scan play)—**PAUSE** (pause)—**D.TITLE INPUT** (disc title input)

—**ITS PLAY** (ITS play)—**ITS MEMORY** (ITS programming)

- You can also switch between the functions in the reverse order by turning **MULTI-CONTROL** counterclockwise.

- To return to the playback display, press **BAND/ESC**.



Note

If you do not operate the function within about 30 seconds, the display is automatically returned to the playback display. 

Repeating play

- During PBC playback of Video CDs, this function cannot be operated.

1 Use **MULTI-CONTROL** to select **PLAY MODE**.

The function name tag **PLAY MODE** is highlighted.

2 Press **MULTI-CONTROL** to select the repeat range.

During DVD video playback

Press **MULTI-CONTROL** repeatedly until the desired repeat range appears in the display.

- **Disc** – Repeat the current disc
- **Chapter** – Repeat just the current chapter
- **Title** – Repeat just the current title

During Video CD or CD playback

Press **MULTI-CONTROL** to turn repeat play on or off.



Notes

- If you select other discs during repeat play, the repeat play range changes to **Disc**.
- If you perform track search or fast forward/reverse during **Track**, the repeat play range changes to **Disc**. 

Pausing disc playback

1 Use MULTI-CONTROL to select PAUSE.
The function name tag **PAUSE** is highlighted.

2 Press MULTI-CONTROL to turn pause on.

Pause:ON appears in the display. Play of the current track pauses.

- To turn pause off, press **MULTI-CONTROL** again.

Playing tracks in a random order

- You can operate this function only during CD playback.

1 Use MULTI-CONTROL to select RANDOM.

The function name tag **RANDOM** is highlighted.

2 Press MULTI-CONTROL to turn random play on.

Random mode:ON appears in the display. Tracks will play in a random order.

- To turn random play off, press **MULTI-CONTROL** again.

Scanning tracks of a CD

- You can operate this function only during CD playback.

1 Use MULTI-CONTROL to select SCAN.

The function name tag **SCAN** is highlighted.

2 Press MULTI-CONTROL to turn scan play on.

Scan mode:ON appears in the display. The first 10 seconds of each track is played.

3 When you find the desired track press MULTI-CONTROL to turn scan play off.

Using ITS playlists

- You can operate these functions only when a multi-DVD player is connected to this unit.
- This function differs slightly from ITS playback with a multi-CD player. With multi-DVD player, ITS playback applies only to the CD playing. For details, refer to *Using ITS playlists* on page 34.

Using disc title functions

You can input CD titles and display the titles. Then you can easily search for and play a desired disc.

Entering disc titles

Disc title input lets you input CD titles up to 10 letters long into the multi-DVD player. For details concerning operation, refer to *Entering disc titles* on page 36.

- You can operate this function only when a multi-DVD player is connected to this unit.

Audio Adjustments

Adjusting the audio easily

The following functions let you easily adjust your audio system to match the car interior acoustic characteristics, which vary depending on the type of car.

- *Recalling equalizer curves*
- *Using the position selector (POSI)*
- *Adjusting equalizer curves (G.EQ 1)*

Adjusting the audio finely

By carrying out the following settings/adjustments in the order shown, you can create a finely-tuned sound field effortlessly.

- *Using the position selector (POSI)*
- *Using balance adjustment (FAD/BAL)*
- *Using subwoofer output (SW 1)*
- *Adjusting subwoofer settings (SW 2)*
- *Adjusting low pass filter attenuation slope (SW 3)*
- *Setting the high pass filter for front speakers (F-HPF 1, F-HPF 2)*
- *Setting the high pass filter for rear speakers (R-HPF 1, R-HPF 2)*
- *Auto TA and EQ (auto-time alignment and auto-equalizing)*
- *Recalling equalizer curves*
- *Adjusting equalizer curves (G.EQ 1)*
- *Adjusting 13-band graphic equalizer (G.EQ 2)*

Extra functions

These functions are helpful in adjusting the sound to suit your system or your personal preferences.

- *Using BBE sound (BBE)*
- *Adjusting loudness (LOUD)*
- *Using automatic sound levelizer (ASL)*
- *Adjusting source levels (SLA)*

Introduction of audio adjustments



① Function name tag

Shows the audio function currently selected in highlighted manner.

② Audio display

Shows the audio adjustments status.

1 Press MULTI-CONTROL to display the main menu.
FUNCTION, AUDIO and **ENTERTAINMENT** appear on the display.

2 Use MULTI-CONTROL to select AUDIO.
 Turn to change the menu option; press to select.
 The audio function name appears on the display.

3 Turn MULTI-CONTROL to select the audio function.
 Turn **MULTI-CONTROL** clockwise to switch between the audio functions in the following order:

FAD/BAL (balance adjustment)—**POSI** (position selector)—**TA 1** (time alignment setting)—**TA 2** (time alignment adjusting)—**LOUD** (loudness)—**G.EQ 1** (graphic equalizer)—**G.EQ 2** (13-band graphic equalizer)—**SW 1** (subwoofer on/off)—**SW 2** (subwoofer cut-off frequency)—**SW 3** (subwoofer slope)—**F-HPF 1** (front high pass filter slope)—**F-HPF 2** (front high pass filter cut-off frequency)—**R-HPF 1** (rear high pass filter slope)—**R-HPF 2** (rear high pass filter cut-off frequency)—**BBE** (BBE)—**AUTO-EQ** (auto-equalizer on/off)—**ASL** (automatic sound levelizer)—**SLA** (source level adjustment)

- You can also switch between the audio functions in the reverse order by turning **MULTI-CONTROL** counterclockwise.
- When selecting the FM tuner as the source, you cannot switch to **SLA**.
- When selecting **TA OFF** in **TA 1**, you cannot switch to **TA 2**.
- You can select **SW 2** and **SW 3** only when subwoofer output is turned on in **SW 1**.
- To return to the display of each source, press **BAND/ESC**.

Note

If you do not operate the audio function within about 30 seconds, the display is automatically returned to the source display. 

Using the position selector

One way to assure a more natural sound is to clearly position the stereo image, putting you right in the center of the sound field. The position selector function lets you automatically adjust the speakers' output levels and inserts a delay time to match the number and position of occupied seats.

1 Use MULTI-CONTROL to select POSI.
The function name tag **POSI** is highlighted.

2 Push MULTI-CONTROL left, right, up or down to select a listening position.

Direction	Display	Position
Left	Front Left	Front seat left
Right	Front Right	Front seat right
Up	Front Seat	Front seats
Down	All seat	All seats

- To cancel the selected listening position, push **MULTI-CONTROL** in the same direction again. 

Using balance adjustment

You can select a fader/balance setting that provides an ideal listening environment in all occupied seats.

1 Use MULTI-CONTROL to select FAD/BAL.

The function name tag **FAD/BAL** is highlighted.

2 Push MULTI-CONTROL up or down to adjust front/rear speaker balance.

Each pushing **MULTI-CONTROL** up or down moves the front/rear speaker balance towards the front or the rear.

Fader F25 – Fader R25 is displayed as the front/rear speaker balance moves from front to rear.

- **Fader FR00** is the proper setting when only two speakers are used.

3 Push MULTI-CONTROL left or right to adjust left/right speaker balance.

Each pushing **MULTI-CONTROL** left or right moves the left/right speaker balance towards the left or the right.

Audio Adjustments

Balance L25 – Balance R25 is displayed as the left/right speaker balance moves from left to right. 

Using the time alignment

The time alignment lets you adjust the distance between each speaker and the listening position.

1 Use MULTI-CONTROL to select TA 1.

The function name tag **TA 1** is highlighted.

2 Push MULTI-CONTROL left or right to select the time alignment.

Each pushing **MULTI-CONTROL** left or right selects time alignment in the following order:

Initial (initial)—**Custom** (custom)—**Auto TA** (auto-time alignment)—**TA OFF** (off)

- **Initial** is the factory supplied time alignment.
- **Custom** is an adjusted time alignment that you can create for yourself.
- **Auto TA** is the time alignment created by auto TA and EQ. (Refer to *Auto TA and EQ (auto-time alignment and auto-equalizing)* on page 55.)
- **Please set Auto TA** appears. This indicates that you cannot select **Auto TA** if auto TA and EQ has not been carried out.

Adjusting the time alignment

You can adjust the distance between each speaker and the selected position.

- An adjusted time alignment is memorized in **Custom**.

1 Use MULTI-CONTROL to select TA 1.

The function name tag **TA 1** is highlighted.

2 Press MULTI-CONTROL to select a unit of distance.

Each press of **MULTI-CONTROL** selects the unit of distance in the following order:

(inch) (inch)—**(cm)** (centimeter)

3 Use MULTI-CONTROL to select TA 2.

The function name tag **TA 2** is highlighted.

Audio Adjustments

- **Can't adjust TA.** Set position **FL/FR** appears when neither **Front Left** nor **Front Right** is selected in the position selector mode (**POSI**).
 - When selecting **TA OFF** in **TA 1**, you cannot switch to **TA 2**.

4 Push **MULTI-CONTROL** left or right to select the speaker to be adjusted.

Each pushing **MULTI-CONTROL** left or right selects the speaker in the following order:

Front L (front left)—**Front R** (front right)
—**Rear R** (rear right)—**Rear L** (rear left)
—**Sub. W** (subwoofer)

- You cannot select **Sub. W** when the subwoofer output is off.

5 Push **MULTI-CONTROL** up or down to adjust the distance between the selected speaker and the listening position.

Each pushing **MULTI-CONTROL** up or down increases or decreases the distance.

160inch – 0inch is displayed as the distance is increased or decreased, if you have selected inches (**(inch)**).

400.0cm – 0.0cm is displayed as the distance is increased or decreased, if you have selected centimeters (**(cm)**).

- You can adjust the distance for the other speakers in the same way.

6 Press **BAND/ESC** to cancel the time alignment mode.

Using subwoofer output

This unit is equipped with a subwoofer output which can be switched on or off. When a subwoofer is connected to this unit, turn the subwoofer output on.

The subwoofer output phase can be switched between normal and reverse.

1 Use **MULTI-CONTROL** to select **SW 1**.

The function name tag **SW 1** is highlighted.

2 Press **MULTI-CONTROL** to turn subwoofer output on.

Sub. W Normal appears in the display. Subwoofer output is now on.

- To turn subwoofer output off, press **MULTI-CONTROL** again.

3 Push **MULTI-CONTROL** left or right to select the phase of subwoofer output.

Push **MULTI-CONTROL** left to select reverse phase and **Sub. W Reverse** appears in the display. Push **MULTI-CONTROL** right to select normal phase and **Sub. W Normal** appears in the display.

Adjusting subwoofer settings

When the subwoofer output is on, you can adjust the cut-off frequency and the output level of the subwoofer.

1 Use **MULTI-CONTROL** to select **SW 2**.

The function name tag **SW 2** is highlighted.

- When the subwoofer output is on, you can select **SW 2**.

2 Push **MULTI-CONTROL** left or right to select cut-off frequency.

Each pushing **MULTI-CONTROL** left or right selects cut-off frequencies in the following order:

50—63—80—100—125—160—200 (Hz)

Only frequencies lower than those in the selected range are outputted from the subwoofer.

3 Push **MULTI-CONTROL** up or down to adjust the output level of the subwoofer.

Each pushing **MULTI-CONTROL** up or down increases or decreases the level of the subwoofer. **+6 – –24** is displayed as the level is increased or decreased.

Audio Adjustments

Adjusting low pass filter attenuation slope

When the subwoofer output is on, you can adjust the continuity of sound between speaker units.

1 Use MULTI-CONTROL to select SW 3.

The function name tag **SW 3** is highlighted.

- When the subwoofer output is on, you can select **SW 3**.

2 Push MULTI-CONTROL left or right to select slope.

Each pushing **MULTI-CONTROL** left or right selects slopes in the following order:

-18—-12—-6 (dB/oct.)



Note

When slope of subwoofer and high pass filter are **-12dB**, and same cut-off frequency, the phase is reversed 180 degrees at the cut-off frequency. In this case, reversing the phase assures improved sound continuity. 

Using the high pass filter

When you do not want low sounds from the subwoofer output frequency range to play from the front or rear speakers, turn on the HPF (high pass filter). Only frequencies higher than those in the selected range are outputted from the front or rear speakers.

Muting the speaker units (filters)

You can mute front and rear speaker units (filters) separately. When speaker units (filters) are muted, no sound is outputted from those speakers.

- If you mute the selected speaker unit (filter), **MUTE** is displayed and no adjustments are possible.
- Even if any speaker unit (filter) is muted, you can adjust the parameters for other speaker units (filters).

1 Use MULTI-CONTROL to select F-HPF 1 (or R-HPF 1).

The function name tag **F-HPF 1** (or **R-HPF 1**) is highlighted.

2 Press and hold MULTI-CONTROL to mute the selected speaker unit (filter).

MUTE is displayed.

- To cancel the muting, press **MULTI-CONTROL** again.

Setting the high pass filter for front speakers

1 Use MULTI-CONTROL to select F-HPF 1.

The function name tag **F-HPF 1** is highlighted.

2 Push MULTI-CONTROL left or right to select slope.

Each pushing **MULTI-CONTROL** left or right selects slopes in the following order:

-12—-6—Pass (0) (dB/oct.)

- If you set the slope to 0 dB/oct. (**Pass**), the audio signal bypasses the filter, so the filter does not have an effect.

3 Turn MULTI-CONTROL to select F-HPF 2.

The function name tag **F-HPF 2** is highlighted.

Audio Adjustments

4 Push MULTI-CONTROL left or right to select cut-off frequency.

Each pushing **MULTI-CONTROL** left or right selects cut-off frequencies in the following order:

50—63—80—100—125—160—200 (Hz)

Only frequencies higher than those in the selected range are output from the front speakers.

5 Push MULTI-CONTROL up or down to adjust the output level of the front speakers.

Each pushing **MULTI-CONTROL** up or down increases or decreases the level of the front speakers. $\pm 0 - -24$ is displayed as the level is increased or decreased.

Setting the high pass filter for rear speakers

1 Use MULTI-CONTROL to select R-HPF 1.

The function name tag **R-HPF 1** is highlighted.

2 Push MULTI-CONTROL left or right to select slope.

Each pushing **MULTI-CONTROL** left or right selects slopes in the following order:

-12—-6—Pass (0) (dB/oct.)

- If you set the slope to 0 dB/oct. (**Pass**), the audio signal bypasses the filter, so the filter does not have an effect.

3 Turn MULTI-CONTROL to select R-HPF 2.

The function name tag **R-HPF 2** is highlighted.

4 Push MULTI-CONTROL left or right to select cut-off frequency.

Each pushing **MULTI-CONTROL** left or right selects cut-off frequencies in the following order:

50—63—80—100—125—160—200 (Hz)

Only frequencies higher than those in the selected range are output from the rear speakers.

5 Push MULTI-CONTROL up or down to adjust the output level of the rear speakers.

Each pushing **MULTI-CONTROL** up or down increases or decreases the level of the rear speakers. $\pm 0 - -24$ is displayed as the level is increased or decreased. 

Using the auto-equalizer

The auto-equalizer is the equalizer curve created by auto TA and EQ (refer to *Auto TA and EQ (auto-time alignment and auto-equalizing)* on page 55).

You can turn the auto-equalizer on or off.

1 Use MULTI-CONTROL to select AUTO-EQ.

The function name tag **AUTO-EQ** is highlighted.

- **Please set Auto EQ** appears. This indicates that you cannot turn the auto-equalizer on if auto TA and EQ has not been carried out.

2 Press MULTI-CONTROL to turn the auto-equalizer on.

Auto EQ ON appears in the display.

- To turn auto-equalizer off, press **MULTI-CONTROL** again. 

Recalling equalizer curves

The equalizer lets you adjust the equalization to match car interior acoustic characteristics as desired.

Audio Adjustments

There are seven stored equalizer curves which you can easily recall at any time. Here is a list of the equalizer curves:

Display	Equalizer curve
POWERFUL	Powerful
NATURAL	Natural
VOCAL	Vocal
FLAT	Flat
CUSTOM1	Custom 1
CUSTOM2	Custom 2
SUPER BASS	Super bass

- **CUSTOM1** and **CUSTOM2** are adjusted equalizer curves that you create. Adjustments can be made with a 13-band graphic equalizer.
- When **FLAT** is selected no supplement or correction is made to the sound. This is useful to check the effect of the equalizer curves by switching alternatively between **FLAT** and a set equalizer curve.

● Press EQ to select the equalizer.

Press **EQ** repeatedly to switch between the following equalizers:

SUPER BASS—**POWERFUL**—**NATURAL**—**VOCAL**—**FLAT**—**CUSTOM1**—**CUSTOM2** 

Adjusting equalizer curves

The factory supplied equalizer curves, with the exception of **FLAT**, can be adjusted to a fine degree (nuance control).

1 Use MULTI-CONTROL to select G.EQ 1.

The function name tag **G.EQ 1** is highlighted.

2 Push MULTI-CONTROL left or right to select an equalizer curve.

3 Push MULTI-CONTROL up or down to adjust the equalizer curve.

Each pushing **MULTI-CONTROL** up or down increases or decreases the equalizer curve respectively.

+6 – **–5** (or **–6**) is displayed as the equalizer curve is increased or decreased.

- The actual range of the adjustments are different depending on which equalizer curve is selected.
- The equalizer curve with all frequencies set to **0** cannot be adjusted. 

Adjusting 13-band graphic equalizer

For **CUSTOM1** and **CUSTOM2** equalizer curves, you can adjust the level of each band.

- A separate **CUSTOM1** curve can be created for each source. (The built-in CD player and the multi-CD player are set to the same equalizer adjustment setting automatically.) If you make adjustments when a curve other than **CUSTOM2** is selected, the equalizer curve settings will be memorized in **CUSTOM1**.
- A **CUSTOM2** curve can be created common to all sources. If you make adjustments when the **CUSTOM2** curve is selected, the **CUSTOM2** curve will be updated.

1 Recall the equalizer curve you want to adjust.

See *Recalling equalizer curves* on the previous page.

2 Use MULTI-CONTROL to select G.EQ 2.

The function name tag **G.EQ 2** is highlighted.

Audio Adjustments

3 Push MULTI-CONTROL left or right to select the equalizer band to adjust.

Each pushing **MULTI-CONTROL** left or right selects equalizer bands in the following order: **50—80—125—200—315—500—800—1.25k—2k—3.15k—5k—8k—12.5k** (Hz)

4 Push MULTI-CONTROL up or down to adjust the level of the equalizer band.

Each pushing **MULTI-CONTROL** up or down increases or decreases the level of the equalizer band.

+6 — -6 is displayed as the level is increased or decreased.

- You can then select another band and adjust the level.

5 Press BAND/ESC to cancel the 13-band graphic equalizer mode.

Using BBE sound

With BBE, playback very close to the original sound can be obtained by correction with a combination of phase compensation and high-range boost for the delay of the high-frequency components and the amplitude deviation occurring during playback. This function makes it possible to reproduce the dynamic sound field as if you are listening to a live performance.

With BBE sound processing technology, you can adjust the level of BBE.

1 Use MULTI-CONTROL to select BBE.

The function name tag **BBE** is highlighted.

2 Press MULTI-CONTROL to turn BBE on.

- To turn BBE off, press **MULTI-CONTROL** again.

3 Push MULTI-CONTROL up or down to adjust the level of BBE.

Each pushing **MULTI-CONTROL** up or down increases or decreases the level of BBE.

+4 — -4 is displayed as the level is increased or decreased.



Note

Manufactured under license from BBE Sound, Inc. The mark BBE is a trademark of BBE Sound, Inc. 

Adjusting loudness

Loudness compensates for deficiencies in the low- and high-sound ranges at low volume.

1 Use MULTI-CONTROL to select LOUD.

The function name tag **LOUD** is highlighted.

2 Press MULTI-CONTROL to turn loudness on.

Loudness ON appears in the display.

- To turn loudness off, press **MULTI-CONTROL** again. 

Using automatic sound levelizer

During driving, noise in the car changes according to the driving speed and road conditions. The automatic sound levelizer (ASL) monitors such varying noise and automatically increases the volume level, if this noise becomes greater. The sensitivity (variation of volume level to noise level) of ASL can be set to one of five levels.

1 Use MULTI-CONTROL to select ASL.

The function name tag **ASL** is highlighted.

Audio Adjustments

2 Press MULTI-CONTROL to turn ASL on.

ASL level (e.g., **Mid-Low**) appears in the display.

- To turn ASL off, press **MULTI-CONTROL** again.

3 Push MULTI-CONTROL up or down to select the desired ASL level.

Each pushing **MULTI-CONTROL** up or down selects ASL level in the following order:

Low (low)—**Mid-Low** (mid-low)—**Mid** (mid)
—**Mid-High** (mid-high)—**High** (high)



Note

When the ASL mode is turned on and exited, **ASL** appears on the display of each source. 

Adjusting source levels

SLA (source level adjustment) lets you adjust the volume level of each source to prevent radical changes in volume when switching between sources.

- Settings are based on the FM tuner volume level, which remains unchanged.

1 Compare the FM tuner volume level with the level of the source you wish to adjust.

2 Use MULTI-CONTROL to select SLA.

The function name tag **SLA** is highlighted.

- When selecting the FM tuner as the source, you cannot switch to **SLA**.

3 Push MULTI-CONTROL up or down to adjust the source volume.

Each pushing **MULTI-CONTROL** up or down increases or decreases the source volume.

+4 – 4 is displayed as the source volume is increased or decreased.



Notes

- The AM tuner volume level can also be adjusted with source level adjustments.
- The built-in CD player and the multi-CD player are set to the same source level adjustment volume automatically.
- External unit 1 and external unit 2 are set to the same source level adjustment volume automatically. 

Auto TA and EQ (auto-time alignment and auto-equalizing)

The auto-time alignment is automatically adjusted for the distance between each speaker and the listening position.

The auto-equalizer automatically measures the car interior acoustic characteristics, and then creates the auto-equalizer curve based on that information.



WARNING

To prevent accidents, never carry out auto TA and EQ while driving. When this function measures the car interior acoustic characteristics to create an auto-equalizer curve, a loud measurement tone (noise) may be outputted from the speakers.



CAUTION

- Carrying out auto TA and EQ under the following conditions may damage the speakers. Be sure to check the conditions thoroughly before carrying out auto TA and EQ.
 - When speakers are incorrectly connected. (e.g., When a rear speaker is connected to a subwoofer output.)

- When a speaker is connected to a power amp delivering output higher than the speaker's maximum input power capability.
- If the microphone is placed in an unsuitable position the measurement tone may become loud and measurement may take a long time, resulting in a drain on battery power. Be sure to place the microphone in the specified location.

Before operating the auto TA and EQ function

- Carry out auto TA and EQ in as quiet a place as possible, with the car engine and air conditioning switched off. Also cut power to car phones or portable telephones in the car, or remove them from the car before carrying out auto TA and EQ. Sounds other than the measurement tone (surrounding sounds, engine sound, telephones ringing etc.) may prevent correct measurement of the car interior acoustic characteristics.
- Be sure to carry out auto TA and EQ using the supplied microphone. Using another microphone may prevent measurement, or result in incorrect measurement of the car interior acoustic characteristics.
- When front speaker is not connected, auto TA and EQ cannot be carried out.
- When muting the front speaker units, auto TA and EQ cannot be carried out. (Refer to page 51.)
- When this unit is connected to a power amp with input level control, auto TA and EQ may not be possible if you lower power amp input level. Set the power amp's input level to the standard position.
- When this unit is connected to a power amp with an LPF, turn off the LPF on the power amp before carrying out auto TA and EQ. In addition, the cut-off frequency for built-in LPF of an active subwoofer should be set to the highest frequency.
- The time alignment value calculated by auto TA and EQ may differ from the actual distance in the following circumstances. However, the distance has been calculated by computer to be the optimum delay to give accurate results for the circumstances, so please continue to use this value.
 - When the reflected sound within a vehicle is strong and delays occur.
 - When delays occur for low sounds due to the influence of the LPF on active subwoofers or external amps.
- Auto TA and EQ changes the audio settings as below:
 - The fader/balance settings return to the center position. (Refer to page 48.)
 - The graphic equalizer curve switches to **FLAT**. (Refer to page 52.)
 - When a subwoofer is connected to this unit, it will be adjusted automatically to both subwoofer output and high pass filter setting for rear speaker.
- If you carry out auto TA and EQ when a previous setting of this already exists, the setting will be replaced.

Carrying out auto TA and EQ

1 Stop the car in a place that is as quiet as possible, close all doors, windows and the sun roof, and then turn the engine off.

If the engine is left running, engine noise may prevent correct auto TA and EQ.

2 Fix the supplied microphone in the center of the headrest of the driver's seat, facing forward, using the belt (sold separately).

The auto TA and EQ may differ depending on where you place the microphone. If desired,

Audio Adjustments

place the microphone on the front passenger seat to carry out auto TA and EQ.

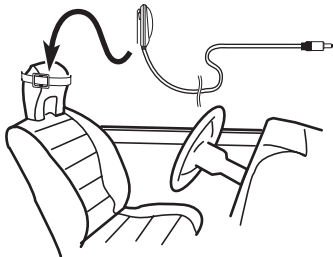

3 Turn the ignition switch to ON or ACC.

If the car's air conditioner or heater is turned on, turn it off. Noise from the fan in the air conditioner or heater may prevent correct auto TA and EQ.

- Press **SOURCE** to turn the source on if this unit is turned off.

4 Select the position for the seat on which the microphone is placed.

Refer to *Using the position selector* on page 48.

- If no position is selected before you start auto TA and EQ, **Front Left** is selected automatically.

5 Press SOURCE and hold until the unit turns off.

6 Press and hold EQ to enter the auto TA and EQ measurement mode.

The front panel opens automatically.

7 Plug the microphone into the microphone input jack on this unit.

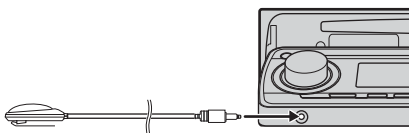

8 Press MULTI-CONTROL to start the auto TA and EQ.

9 Get out of the car and close the door within 10 seconds when the 10-second count-down starts.

The measurement tone (noise) is outputted from the speakers, and auto TA and EQ begins.

- When all speakers are connected, auto TA and EQ is completed in about six minutes.
- To stop auto TA and EQ, press **MULTI-CONTROL** again.
- To cancel auto TA and EQ part way through, press **BAND/ESC**.

10 When auto TA and EQ is completed, Complete is displayed.

When correct measurement of car interior acoustic characteristics is not possible, an error message is displayed. (Refer to *Understanding auto TA and EQ error messages* on page 65.)

11 Press BAND/ESC to cancel the auto TA and EQ mode.

12 Store the microphone carefully in the glove compartment.

Store the microphone carefully in the glove compartment or any other safe place. If the microphone is subjected to direct sunlight for an extended period, high temperatures may cause distortion, color change or malfunction. □

Adjusting initial settings

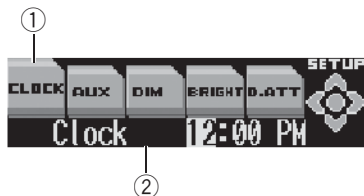

Initial settings lets you perform initial setup of different settings for this unit.

① Function name tag

Shows the function currently selected in highlighted manner.

② Function display

Shows the function status.

1 Press SOURCE and hold until the unit turns off.

2 Press MULTI-CONTROL and hold until the clock appears in the display.

3 Turn MULTI-CONTROL to select one of the initial settings.

Turn **MULTI-CONTROL** clockwise to switch between the functions in the following order:

CLOCK (clock)—**AUX** (auxiliary input)—**DIM** (dimmer)—**BRIGHT** (brightness)—**D.ATT** (digital attenuator)—**MUTE** (telephone muting/attenuation)—**WARN** (warning tone)—**DEMO** (feature demo)—**REV** (reverse mode)—**FONT** (font)—**SCROLL** (ever scroll)—**AUTO OPEN** (flap auto open)

- You can also switch between the functions in the reverse order by turning **MULTI-CONTROL** counterclockwise.

- To cancel initial settings, press **BAND/ESC**.

Setting the clock

Use these instructions to set the clock.

1 Use **MULTI-CONTROL** to select **CLOCK**.

The function name tag **CLOCK** is highlighted.

2 Push **MULTI-CONTROL** left or right to select the segment of the clock display you wish to set.

Pushing **MULTI-CONTROL** left or right will select one segment of the clock display:

Hour—Minute

As you select segments of the clock display the segment selected will blink.



3 Push **MULTI-CONTROL** up or down to set the clock.

Pushing **MULTI-CONTROL** up will increase the selected hour or minute. Pushing **MULTI-CONTROL** down will decrease the selected hour or minute.



Note

You can match the clock to a time signal by pressing **MULTI-CONTROL**.

- If the minute is **00—29**, the minutes are rounded down. (e.g., **10:18** becomes **10:00**.)
- If the minute is **30—59**, the minutes are rounded up. (e.g., **10:36** becomes **11:00**.)

Switching the auxiliary setting

It is possible to use auxiliary equipment with this unit. Activate the auxiliary setting when using auxiliary equipment connected to this unit.

Initial Settings

1 Use **MULTI-CONTROL** to select **AUX**.

The function name tag **AUX** is highlighted.

2 Press **MULTI-CONTROL** to turn **AUX** on.

AUX:ON appears in the display.

- To turn **AUX** off, press **MULTI-CONTROL** again. 

Switching the dimmer setting

To prevent the display from being too bright at night, the display is automatically dimmed when the car's headlights are turned on. You can turn the dimmer on or off.

1 Use **MULTI-CONTROL** to select **DIM**.

The function name tag **DIM** is highlighted.

2 Press **MULTI-CONTROL** to turn dimmer on.

Dimmer:ON appears in the display.

- To turn dimmer off, press **MULTI-CONTROL** again. 

Adjusting the brightness

Display brightness adjustment lets you adjust the display for easier viewing when lighting conditions change.

1 Use **MULTI-CONTROL** to select **BRIGHT**.

The function name tag **BRIGHT** is highlighted.

2 Push **MULTI-CONTROL** left or right to adjust the brightness level.

Each pushing **MULTI-CONTROL** left or right increases or decreases the brightness level. **0** – **31** is displayed as the level is increased or decreased. 

Correcting distorted sound

When listening to a CD or other source on which the recording level is high, setting the equalizer curve level to high may result in distortion. You can switch the digital attenuator to low to reduce distortion.

- Sound quality is better at the high setting so this setting is usually used.

1 Use **MULTI-CONTROL** to select **D.ATT**.

The function name tag **D.ATT** is highlighted.

2 Press **MULTI-CONTROL** to select the digital attenuator level.

Pressing **MULTI-CONTROL** repeatedly will switch between **High** (high) and **Low** (low) and that status will be displayed. 

Switching the sound muting/attenuation

Sound from this system is muted or attenuated automatically when a call is made or received using a cellular telephone connected to this unit.

- The sound is turned off, **MUTE** is displayed and no audio adjustments are possible.
- The sound is attenuated, **ATT** is displayed and no audio adjustments, except volume control, are possible.
- Operation returns to normal when the phone connection is ended.

1 Use **MULTI-CONTROL** to select **MUTE**.

The function name tag **MUTE** is highlighted.

2 Press **MULTI-CONTROL** to select the desired setting.

Press **MULTI-CONTROL** repeatedly to switch between the following settings:

- **10dB ATT** – Attenuation

- **20dB ATT** – Attenuation (**20dB ATT** has a stronger effect than **10dB ATT**)
- **TEL mute** – Muting 

Switching the warning tone

If the front panel is not detached from the head unit within five seconds of turning off the ignition, a warning tone will sound. You can turn off the warning tone.

1 Use MULTI-CONTROL to select WARN.
The function name tag **WARN** is highlighted.

2 Press MULTI-CONTROL to turn warning tone on.

Warning tone :ON appears in the display.

- To turn warning tone off, press

MULTI-CONTROL again. 

Using the feature demo

The feature demo automatically starts when power to this unit is turned off while the ignition switch is set to ACC or ON.

You can turn the feature demo on or off.



Important

The red lead (ACC) of this unit should be connected to a terminal coupled with ignition switch on/off operations. If this is not done, the vehicle battery may be drained.

1 Use MULTI-CONTROL to select DEMO.
The function name tag **DEMO** is highlighted.

2 Press MULTI-CONTROL to turn the feature demo on.

Demonstration :ON appears in the display.

- To turn the feature demo off, press

MULTI-CONTROL again. 

Using reverse mode

If you do not perform an operation within about 30 seconds, screen indications start to reverse, and then continue reversing every 10 seconds.

You can turn the reverse mode on or off.

- Some entertainment displays may not operate the reverse mode.

1 Use MULTI-CONTROL to select REV.

The function name tag **REV** is highlighted.

2 Press MULTI-CONTROL to turn the reverse mode on.

Reverse mode :ON appears in the display.

- To turn the reverse mode off, press **MULTI-CONTROL** again. 

Switching the font

There are two kinds of fonts to select from.

1 Use MULTI-CONTROL to select FONT.

The function name tag **FONT** is highlighted.

2 Press MULTI-CONTROL to select the desired font.

Pressing **MULTI-CONTROL** repeatedly will switch between **Type1** (type 1) and **Type2** (type 2) and that status will be displayed. 

Switching the Ever Scroll

When Ever Scroll is set to ON, CD text information scrolls continuously in the display. Set to OFF if you prefer the information to scroll just once.

1 Use MULTI-CONTROL to select SCROLL.

The function name tag **SCROLL** is highlighted.

Initial Settings

2 Press **MULTI-CONTROL** to turn the Ever Scroll on.

Ever-scroll :ON appears in the display.

- To turn the Ever Scroll off, press **MULTI-CONTROL** again. 

Switching the flap auto open

For theft protection, the front panel opens automatically and easily detaches. Flap auto open is on as a default.

1 Use **MULTI-CONTROL** to select **AUTO OPEN**.

The function name tag **AUTO OPEN** is highlighted.

2 Press **MULTI-CONTROL** to turn the flap auto open on.

Face auto open :ON appears in the display.

- To turn the flap auto open off, press **MULTI-CONTROL** again. 

Turning the clock display on or off

You can turn the clock display on or off.

- **Press CLOCK to turn the clock display on or off.**

Each press of **CLOCK** turns the clock display on or off.



Note

Even when the sources and the feature demo are off, the clock display appears on the display.

Pressing **CLOCK** turns the clock display on or off.

Using the AUX source

An IP-BUS-RCA Interconnector such as the CD-RB20/CD-RB10 (sold separately) lets you connect this unit to auxiliary equipment featuring RCA output. For more details, refer to the IP-BUS-RCA Interconnector owner's manual.

Selecting AUX as the source

- **Press SOURCE to select AUX as the source.**

Press **SOURCE** until **AUX** appears in the display.

- If the auxiliary setting is not turned on, **AUX** cannot be selected. For more details, see *Switching the auxiliary setting* on page 58.

Setting the AUX title

The title displayed for the **AUX** source can be changed.

- 1 After you have selected **AUX** as the source, use **MULTI-CONTROL** and select **FUNCTION** to display **TITLE INPUT**.

- 2 Press button **1** to select the desired character type.

Press button **1** repeatedly to switch between the following character types:
 Alphabet (upper case), numbers and symbols
 —Alphabet (lower case)—European letters, such as those with accents (e.g., **á, à, ä, ç**)

- You can select to input numbers and symbols by pressing button **2**.

- 3 Push **MULTI-CONTROL** up or down to select a letter of the alphabet.

Each pushing **MULTI-CONTROL** up will display a letter of the alphabet in **A B C ... X Y Z**, numbers and symbols in **1 2 3 ... @ # <** order. Each pushing **MULTI-CONTROL** down will display a letter in the reverse order, such as **Z Y X ... C B A**.



- 4 Push **MULTI-CONTROL** right to move the cursor to the next character position.

When the letter you want is displayed, push **MULTI-CONTROL** right to move the cursor to the next position and then select the next letter. Push **MULTI-CONTROL** left to move backwards in the display.

- 5 Move the cursor to the last position by pushing **MULTI-CONTROL** right after entering the title.

When you push **MULTI-CONTROL** right one more time, the entered title is stored in memory.

- 6 Press **BAND/ESC** to return to the playback display.

Other Functions

Using different entertainment displays

You can enjoy entertainment displays while listening to each sound source.

1 Press MULTI-CONTROL to display the main menu.

FUNCTION, **AUDIO** and **ENTERTAINMENT** appear on the display.

2 Use MULTI-CONTROL to select ENTERTAINMENT.

Turn to change the menu option; press to select.

The entertainment display currently selected appears on the display.

3 Turn MULTI-CONTROL to change the display.

Turn **MULTI-CONTROL** clockwise to switch between the displays in the following order:

BGV 1 (background visual 1)—**BGV 2** (background visual 2)—**BGV 3** (background visual 3)—**BGV 4** (background visual 4)—**BGP 1** (background picture 1)—**BGP 2** (background picture 2)—**BGP 3** (background picture 3)—**BGP 4** (background picture 4)—**BGP 5** (background picture 5)—**S/A 1** (spectrum analyzer 1)—**S/A 2** (spectrum analyzer 2)—**LEVEL 1** (level meter 1)—**LEVEL 2** (level meter 2)—**E.CLK** (entertainment clock)—**OFF** (entertainment display OFF)—**MOVIE 1** (movie 1)—**MOVIE 2** (movie 2)

- You can also switch between the displays in the reverse order by turning **MULTI-CONTROL** counterclockwise.
- To cancel the entertainment display mode, press **BAND/ESC**.

4 Press MULTI-CONTROL to select the current display.

The selected entertainment display is displayed.

Using the PGM button

You can operate the preprogrammed functions for each source by using **PGM**.

● Press PGM to turn pause on when selecting the following sources:

- Built-in CD Player
- DVD player/multi-DVD player
- Multi-CD Player
- To turn pause off, press **PGM** again.

● Press PGM and hold to turn BSM on when selecting Tuner as the source.

Press **PGM** and hold until the BSM turns on.

- To cancel the storage process, press **PGM** again.

● Press PGM and hold to turn BSSM on when selecting TV as the source.

Press **PGM** and hold until the BSSM turns on.

- To cancel the storage process, press **PGM** again.

● Press PGM to select the desired channel select setting when selecting XM as the source.

Press **PGM** repeatedly to switch between the following channel select settings:

Channel Number (channel number select setting)—**Category** (channel category select setting)

Rewriting the entertainment displays

You can rewrite the entertainment display.

Please create or download the data using your Computer, and record it on CD-R. For details, please visit <http://www.pioneer.co.jp/car/pclink3a/>.

Important

Once the rewriting process has started, do not remove the front panel or turn the ignition off, until it is completed.

1 Press SOURCE and hold until the unit turns off.

2 Press and hold EQ and DISPLAY until the unit goes into download mode.

Front panel is opened automatically and then **Download** and **Insert disc** is displayed.

- If a disc is loaded in the unit, it is ejected automatically.
- When the front panel is open, does not go into download mode even if you press and hold **EQ** and **DISPLAY**.

3 Insert the disc containing the rewritten data into the CD loading slot.

Download Ready appears in the display, and then data rewriting will start automatically.

Now loading is displayed during rewriting.

CD loading slot

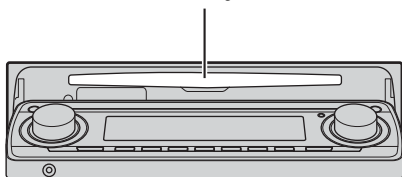

4 After Finished is displayed, press EJECT to eject the disc.

Download mode is exited and unit turns off.

Notes

- Do not insert anything other than a CD into the CD loading slot.
- It can take several minutes to complete this operation.
- During download mode, buttons other than **EJECT** are inactive.

- To cancel download mode, press **EJECT**.
- If the rewriting process does not operate properly, an error message such as **CD ERROR** may be displayed. Refer to *Understanding error message on rewriting the entertainment displays* on the next page. 

Additional Information

Understanding built-in CD player error messages

When problems occur during CD play an error message may appear on the display. If an error message appears, refer to the table below to see what the problem is and the suggested method of correcting the problem. If the error cannot be corrected, contact your dealer or your nearest Pioneer Service Center.

Message	Cause	Action
ERROR-11, 12, 17, 30	Dirty disc	Clean disc.
ERROR-11, 12, 17, 30	Scratched disc	Replace disc.
ERROR-10, 11, 12, 17, 30, A0	Electrical or mechanical	Turn the ignition ON and OFF, or switch to a different source, then back to the CD player.
ERROR-22, 23	The CD format cannot be played back	Replace disc.
ERROR-44	All tracks are skip tracks	Replace disc.



Understanding auto TA and EQ error messages

When correct measurement of car interior acoustic characteristics is not possible using the auto TA and EQ, an error message may appear on the display. If an error message appears, refer to the table below to see what the problem is and the suggested method of correcting the problem. After checking, try again.

Message	Cause	Action
Error check MIC	Microphone is not connected.	Plug the supplied microphone securely into the jack.
Error check front SP, Error check FL SP, Error check FR SP, Error check RL SP, Error check RR SP, Error check SW	The microphone cannot pick up the measuring tone of a speaker.	<ul style="list-style-type: none"> • Confirm that the speakers are connected correctly. • Cancel muting the front speaker units. • Correct the input level setting of the power amp connected to the speakers. • Set the microphone correctly.
Error check noise	The surrounding noise level is too high.	<ul style="list-style-type: none"> • Stop your car in a place that is as quiet as possible, and switch off the engine, air conditioner or heater. • Set the microphone correctly.



Understanding error message on rewriting the entertainment displays

When problems occur during rewriting the entertainment displays an error message may appear on the display. If an error message appears refer to the table below to see what the problem is and the suggested method of correcting the problem. If the error cannot be corrected, contact your dealer or your nearest Pioneer Service Center.

Message	Cause	Action
CD ERROR	CD player error	Press EJECT and check the disc.

Additional Information

Message	Cause	Action
CD ERROR A0	Electrical error	Turn the ignition ON and OFF.
Disc ERROR	The disc does not contain the necessary data	Press EJECT and replace the disc.
Download ERROR, Transmit ERROR	Writing error	Press EJECT and retry the rewriting.
FILE ERROR	File error	Rewrite the file.



CD player and care

- Use only CDs that have either of the two Compact Disc Digital Audio marks as shown below.



- Use only normal, round CDs. If you insert irregular, non-round, shaped CDs they may jam in the CD player or not play properly.

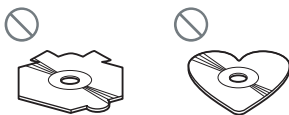

- Check all CDs for cracks, scratches or warping before playing. CDs that have cracks, scratches or are warped may not play properly. Do not use such discs.
- Avoid touching the recorded (non-printed) surface when handling the disc.
- Store discs in their cases when not in use.
- Keep discs out of direct sunlight and do not expose the discs to high temperatures.
- Do not attach labels, write on or apply chemicals to the surface of the discs.

- To clean a CD, wipe the disc with a soft cloth outward from the center.



- If the heater is used in cold weather, moisture may form on components inside the CD player. Condensation may cause the CD player to malfunction. If you think that condensation is a problem turn off the CD player for an hour or so to allow it to dry out and wipe any damp discs with a soft cloth to remove the moisture.
- Road shocks may interrupt CD playback. ■

CD-R/CD-RW discs

- When CD-R/CD-RW discs are used, playback is possible only for discs which have been finalized.
- It may not be possible to play back CD-R/CD-RW discs recorded on a music CD recorder or a personal computer because of disc characteristics, scratches or dirt on the disc, or dirt, condensation, etc., on the lens of this unit.
- Playback of discs recorded on a personal computer may not be possible, depending on the application settings and the environment. Please record with the correct format. (For details, contact the manufacturer of the application.)
- Playback of CD-R/CD-RW discs may become impossible in case of direct exposure to sunlight, high temperatures, or the storage conditions in the car.
- Titles and other text information recorded on a CD-R/CD-RW disc may not be displayed by this unit (in the case of audio data (CD-DA)).

Additional Information

- This unit conforms to the track skip function of the CD-R/CD-RW disc. The tracks containing the track skip information are skipped automatically (in case of audio data (CD-DA)).
- If you insert a CD-RW disc into this unit, time to playback will be longer than when you insert a conventional CD or CD-R disc.
- Read the precautions with CD-R/CD-RW discs before using them. 

MP3, WMA and WAV files

- MP3 is short for MPEG Audio Layer 3 and refers to an audio compression technology standard.
- WMA is short for Windows Media™ Audio and refers to an audio compression technology that is developed by Microsoft Corporation. WMA data can be encoded by using Windows Media Player version 7 or later.
- WAV is short for waveform. It is a standard audio file format for Windows®.
- With some applications used to encode WMA files, this unit may not operate correctly.
- With some applications used to encode WMA files, album names and other text information may not be correctly displayed.
- This unit allows playback of MP3/WMA/WAV files on CD-ROM, CD-R and CD-RW discs. Disc recordings compatible with level 1 and level 2 of ISO9660 and with the Romeo and Joliet file system can be played back.
- It is possible to play back multi-session compatible recorded discs.
- MP3/WMA/WAV files are not compatible with packet write data transfer.
- The maximum number of characters which can be displayed for a file name, including

the extension (.mp3, .wma or .wav), is 64, from the first character.

- The maximum number of characters which can be displayed for a folder name is 64.
- In case of files recorded according to the Romeo file system, only the first 64 characters can be displayed.
- When playing discs with MP3/WMA/WAV files and audio data (CD-DA) such as CD-EXTRA and MIXED-MODE CDs, both types can be played only by switching mode between MP3/WMA/WAV and CD-DA.
- The folder selection sequence for playback and other operations becomes the writing sequence used by the writing software. For this reason, the expected sequence at the time of playback may not coincide with the actual playback sequence. However, there also is some writing software which permits setting of the playback order.

Important

- When naming an MP3/WMA/WAV file, add the corresponding filename extension (.mp3, .wma or .wav).
- This unit plays back files with the filename extension (.mp3, .wma or .wav) as an MP3/WMA/WAV file. To prevent noise and malfunctions, do not use these extensions for files other than MP3/WMA/WAV files.

MP3 additional information

- Files are compatible with the ID3 Tag Ver. 1.0, 1.1, 2.2, 2.3 and 2.4 formats for display of album (disc title), track (track title), artist (track artist) and comments. Ver. 2.x of ID3 Tag is given priority when both Ver. 1.x and Ver. 2.x exist.

Additional Information

- The emphasis function is valid only when MP3 files of 32, 44.1 and 48 kHz frequencies are played back. (16, 22.05, 24, 32, 44.1, 48 kHz sampling frequencies can be played back.)
- There is no m3u playlist compatibility.
- There is no compatibility with the MP3i (MP3 interactive) or mp3 PRO formats.
- The sound quality of MP3 files generally becomes better with an increased bit rate. This unit can play recordings with bit rates from 8 kbps to 320 kbps, but in order to be able to enjoy sound of a certain quality, we recommend using only discs recorded with a bit rate of at least 128 kbps.
- You can only play back WAV files in the frequencies 16, 22.05, 24, 32, 44.1 and 48 kHz (LPCM), or 22.05 and 44.1 kHz (MS ADPCM). The sampling frequency shown in the display may be rounded.
- The sound quality of WAV files generally becomes better with a larger number of quantization bits. This unit can play recordings with 8 and 16 (LPCM) or 4 (MS ADPCM) quantization bits, but in order to be able to enjoy sound of a certain quality, we recommend using discs recorded with the larger number of quantization bits.

WMA additional information

- This unit plays back WMA files encoded by Windows Media Player version 7, 7.1, 8 and 9.
- You can only play back WMA files in the frequencies 32, 44.1 and 48 kHz.
- The sound quality of WMA files generally becomes better with an increased bit rate. This unit can play recordings with bit rates from 48 kbps to 320 kbps (CBR) or from 48 kbps to 384 kbps (VBR), but in order to be able to enjoy sound of a certain quality, we recommend using discs recorded with a higher bit rate.
- This unit doesn't support the following formats.
 - Windows Media Audio 9 Professional (5.1ch)
 - Windows Media Audio 9 Lossless
 - Windows Media Audio 9 Voice

WAV additional information

- This unit plays back WAV files encoded in Linear PCM (LPCM) format or MS ADPCM format.

About folders and MP3/WMA/WAV files

- An outline of a CD-ROM with MP3/WMA/WAV files on it is shown below. Subfolders are shown as folders in the folder currently selected.

Additional Information

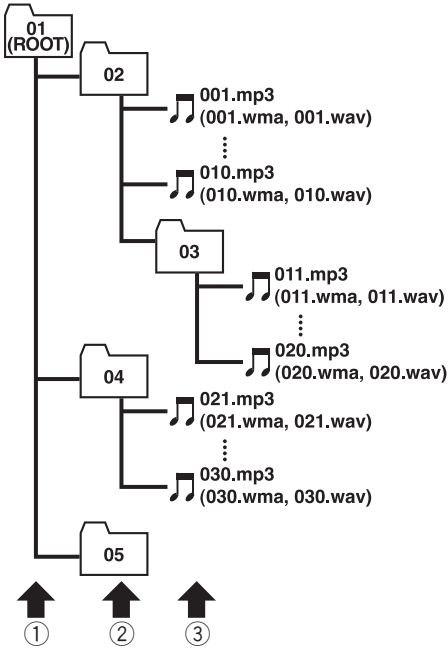

- ① **First level**
- ② **Second level**
- ③ **Third level**

Notes

- This unit assigns folder numbers. The user can not assign folder numbers.
- It is not possible to check folders that do not include MP3/WMA/WAV files. (These folders will be skipped without displaying the folder number.)
- MP3/WMA/WAV files in up to 8 tiers of folders can be played back. However, there is a delay in the start of playback on discs with numerous tiers. For this reason we recommend creating discs with no more than 2 tiers.

- It is possible to play back up to 99 folders on one disc.

Additional Information

Terms

Bit rate

This expresses data volume per second, or bps units (bits per second). The higher the rate, the more information is available to reproduce the sound. Using the same encoding method (such as MP3), the higher the rate, the better the sound.

ID3 tag

This is a method of embedding track-related information in an MP3 file. This embedded information can include the track title, the artist's name, the album title, the music genre, the year of production, comments and other data. The contents can be freely edited using software with ID3 Tag editing functions. Although the tags are restricted as to the number of characters, the information can be viewed when the track is played back.

ISO9660 format

This is the international standard for the format logic of CD-ROM folders and files. For the ISO9660 format, there are regulations for the following two levels.

Level 1:

The file name is in 8.3 format (the name consists of up to 8 characters, half-byte English capital letters and half-byte numerals and the “_” sign, with a file-extension of three characters.)

Level 2:

The file name can have up to 31 characters (including the separation mark “.” and a file extension). Each folder contains less than 8 hierarchies.

Extended formats

Joliet:

File names can have up to 64 characters.

Romeo:

File names can have up to 128 characters.

Linear PCM (LPCM)/Pulse code modulation

This stands for linear pulse code modulation, which is the signal recording system used for music CDs and DVDs.

m3u

Playlists created using the “WINAMP” software have a playlist file extension (.m3u).

MP3

MP3 is short for MPEG Audio Layer 3. It is an audio compression standard set by a working group (MPEG) of the ISO (International Standards Organization). MP3 is able to compress audio data to about 1/10th the level of a conventional disc.

MS ADPCM

This stands for Microsoft adaptive differential pulse code modulation, which is the signal recording system used for the multimedia software of Microsoft Corporation.

Multi-session

Multi-session is a recording method that allows additional data to be recorded later. When recording data on a CD-ROM, CD-R or CD-RW, etc., all data from beginning to end is treated as a single unit or session. Multi-session is a method of recording more than 2 sessions on one disc.

Number of quantization bits

The number of quantization bits is one factor in the overall sound quality; the higher the “bit-depth”, the better the sound quality. However, increasing the bit-depth also increases the amount of data and therefore storage space required.

Packet write

This is a general term for a method of writing on CD-R, etc., at the time required for a file,

Additional Information

just as is done with files on floppy or hard discs.

VBR

VBR is short for variable bit rate. Generally speaking CBR (constant bit rate) is more widely used. But by flexibly adjusting the bit rate according to the needs of audio compression, it is possible to achieve compression-priority sound quality.

WAV

WAV is short for waveform. It is a standard audio file format for Windows®.

WMA

WMA is short for Windows Media™ Audio and refers to an audio compression technology that is developed by Microsoft Corporation. WMA data can be encoded by using Windows Media Player version 7 or later. Microsoft, Windows Media, and the Windows logo are trademarks, or registered trademarks of Microsoft Corporation in the United States and/or other countries. ▣

Additional Information

Specifications

General

Power source	14.4 V DC (10.8 – 15.1 V allowable)
Grounding system	Negative type
Max. current consumption	10.0 A
Dimensions (W × H × D):	
DIN	
Chassis	178 × 50 × 159 mm (7 × 2 × 6-1/4 in.)
Nose	188 × 58 × 29 mm (7-3/8 × 2-1/4 × 1-1/8 in.)
D	
Chassis	178 × 50 × 164 mm (7 × 2 × 6-1/2 in.)
Nose	170 × 45 × 24 mm (6-3/4 × 1-3/4 × 1 in.)
Weight	1.6 kg (3.5 lbs)

Audio/DSP

Continuous power output is 22 W per channel minimum into 4 ohms, both channels driven 50 to 15,000 Hz with no more than 5% THD.	
Maximum power output	50 W × 4
Load impedance	4 Ω (4 – 8 Ω allowable)
Preout max output level/output impedance	4.0 V/100 Ω
Loudness contour	+10 dB (100 Hz), +6.5 dB (10 kHz) (volume: –30 dB)
Equalizer (13-Band Graphic Equalizer):	
Frequency	50/80/125/200/315/500/800 Hz 1.25/2/3.15/5/8/12.5 kHz
Equalization range	±12 dB
Auto equalizer:	
(Front & rear & subwoofer 13 band graphic)	
Frequency	50/80/125/200/315/500/800 Hz 1.25/2/3.15/5/8/12.5 kHz
Equalization range	+6 – –12 dB
HPF (Front/rear):	
Frequency	50/63/80/100/125/160/200 Hz
Slope	0 (Pass)/–6/–12 dB/oct
Gain	0 – –24 dB/Mute
Subwoofer:	
Frequency	50/63/80/100/125/160/200 Hz
Slope	–6/–12/–18 dB/oct
Gain	+6 – –24 dB/Mute

Phase Normal/Reverse

CD player

System	Compact disc audio system
Usable discs	Compact disc
Signal format:	
Sampling frequency	44.1 kHz
Number of quantization bits	16; linear
Frequency characteristics	5 – 20,000 Hz (±1 dB)
Signal-to-noise ratio	100 dB (1 kHz) (IHF-A network)
Dynamic range	95 dB (1 kHz)
Number of channels	2 (stereo)
MP3 decoding format	MPEG-1 & 2 Audio Layer 3
WMA decoding format	Ver. 7, 7.1, 8, 9 (2ch audio)
WAV signal format	Linear PCM & MS ADPCM

FM tuner

Frequency range	87.9 – 107.9 MHz
Usable sensitivity	8 dBf (0.7 μV/75 Ω mono, S/N: 30 dB)
50 dB quieting sensitivity	10 dBf (0.9 μV/75 Ω mono)
Signal-to-noise ratio	75 dB (IHF-A network)
Distortion	0.3 % (at 65 dBf, 1 kHz, stereo) 0.1 % (at 65 dBf, 1 kHz, mono)
Frequency response	30 – 15,000 Hz (±3 dB)
Stereo separation	45 dB (at 65 dBf, 1 kHz)
Selectivity	80 dB (±200 kHz)
Three-signal intermodulation (desired signal level)	30 dBf (two undesired signal level: 100 dBf)

AM tuner

Frequency range	530 – 1,710 kHz (10 kHz)
Usable sensitivity	18 μV (S/N: 20 dB)
Signal-to-noise ratio	65 dB (IHF-A network)



Note

Specifications and the design are subject to possible modifications without notice due to improvements. □

*Register your product at
Enregistrez votre produit au*

<http://www.pioneerelectronics.com>

*See "Product registration" page
Voir la page "Enregistrement du produit"*

PIONEER CORPORATION

4-1, MEGURO 1-CHOME, MEGURO-KU, TOKYO 153-8654, JAPAN

PIONEER ELECTRONICS (USA) INC.

P.O. Box 1540, Long Beach, California 90801-1540, U.S.A.

TEL: (800) 421-1404

PIONEER EUROPE NV

Haven 1087, Keetberglaan 1, B-9120 Melsele, Belgium

TEL: (0) 3/570.05.11

PIONEER ELECTRONICS ASIACENTRE PTE. LTD.

253 Alexandra Road, #04-01, Singapore 159936

TEL: 65-6472-1111

PIONEER ELECTRONICS AUSTRALIA PTY. LTD.

178-184 Boundary Road, Braeside, Victoria 3195, Australia

TEL: (03) 9586-6300

PIONEER ELECTRONICS OF CANADA, INC.

300 Allstate Parkway, Markham, Ontario L3R OP2, Canada

TEL: (905) 479-4411

PIONEER ELECTRONICS DE MEXICO, S.A. de C.V.

Bvd.Manuel Avila Camacho 138 10 piso

Col.Lomas de Chapultepec, Mexico, D.F. 11000

TEL: 55-9178-4270

先鋒股份有限公司

總公司：台北市中山北路二段44號13樓

電話：(02) 2521-3588

先鋒電子（香港）有限公司

香港九龍尖沙咀海港城世界商業中心

9樓901-6室

電話：(0852) 2848-6488

Published by Pioneer Corporation.

Copyright © 2003 by Pioneer Corporation.

All rights reserved.

Publié par Pioneer Corporation. Copyright

© 2003 par Pioneer Corporation. Tous

droits réservés.

Printed in Thailand

Imprimé en Thaïlande

<CRD3830-A/N> UC

<KMMZX> <03L00000>

DEH-P8600MP

This product conforms to CEMA cord colors.
Le code de couleur des câbles utilisé pour ce produit est conforme à CEMA.

Connecting the Units

Note:

- This unit is for vehicles with a 12-volt battery and negative grounding. Before installing it in a recreational vehicle, truck, or bus, check the battery voltage.
- To avoid shorts in the electrical system, be sure to disconnect the \ominus battery cable before beginning installation.
- Refer to the owner's manual for details on connecting the power amp and other units, then make connections correctly.
- Secure the wiring with cable clamps or adhesive tape. To protect the wiring, wrap adhesive tape around them where they lie against metal parts.
- Route and secure all wiring so it cannot touch any moving parts, such as the gear shift, handbrake and seat rails. Do not route wiring in places that get hot, such as near the heater outlet. If the insulation of the wiring melts or gets torn, there is a danger of the wiring short-circuiting to the vehicle body.
- Don't pass the yellow lead through a hole into the engine compartment to connect to the battery. This will damage the lead insulation and cause a very dangerous short.
- Do not shorten any leads. If you do, the protection circuit may fail to work when it should.
- Never feed power to other equipment by cutting the insulation of the power supply lead of the unit and tapping into the lead. The current capacity of the lead will be exceeded, causing overheating.
- When replacing fuse, be sure to use only fuse of the rating prescribed on the fuse holder.
- Since a unique BPTL circuit is employed, never wire so the speaker leads are directly grounded or the left and right \ominus speaker leads are common.
- If the RCA pin jack on the unit will not be used, do not remove the caps attached to the end of the connector.
- Speakers connected to this unit must be high-power types with minimum rating of 50 W and impedance of 4 to 8 ohms. Connecting speakers with output and/or impedance values other than those noted here may result in the speakers catching fire, emitting smoke, or becoming damaged.

- When this product's source is switched ON, a control signal is output through the blue/white lead. Connect to an external power amp's system remote control or the car's Auto-antenna relay control terminal (max. 300 mA 12 V DC). If the car features a glass antenna, connect to the antenna booster power supply terminal.
- When an external power amp is being used with this system, be sure not to connect the blue/white lead to the amp's power terminal. Likewise, do not connect the blue/white lead to the power terminal of the auto-antenna. Such connection could cause excessive current drain and malfunction.
- To avoid short-circuiting, cover the disconnected lead with insulating tape. Especially, insulate the unused speaker leads without fail. There is a possibility of short-circuiting if the leads are not insulated.
- To prevent incorrect connection, the input side of the IP-BUS connector is blue, and the output side is black. Connect the connectors of the same colors correctly.
- If this unit is installed in a vehicle that does not have an ACC (accessory) position on the ignition switch, the red lead of the unit should be connected to a terminal coupled with ignition switch ON/OFF operations. If this is not done, the vehicle battery may be drained when you are away from the vehicle for several hours. (Fig. 1)

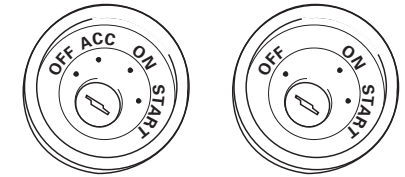

ACC position

No ACC position

Fig. 1

- The black lead is ground. Please ground this lead separately from the ground of high-current products such as power amps.
If you ground the products together and the ground becomes detached, there is a risk of damage to the products or fire.
- Cords for this product and those for other products may be different colors even if they have the same function. When connecting this product to another product, refer to the supplied manuals of both products and connect cords that have the same function.

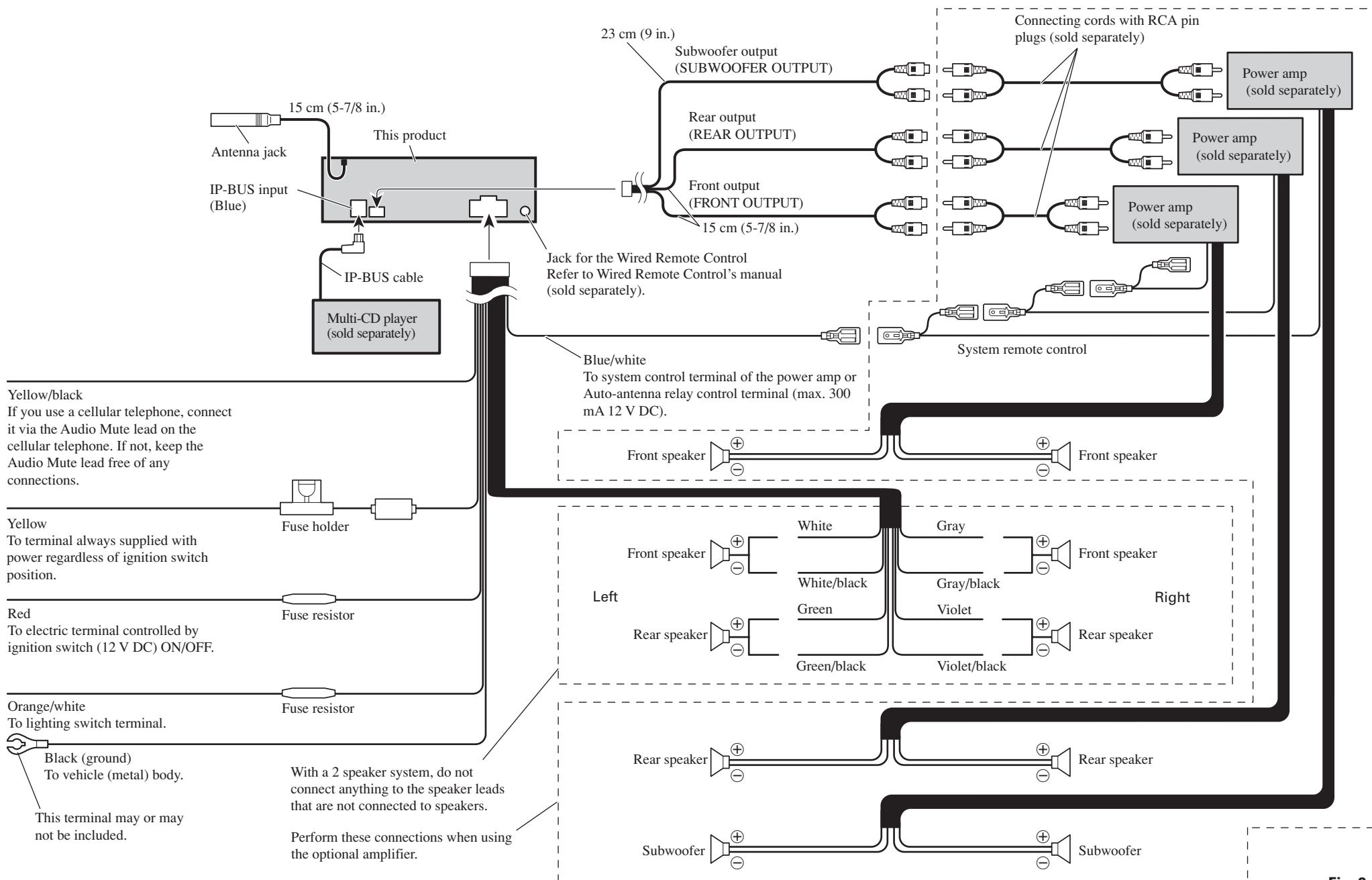

Fig. 2

Installation

Note:

- Before finally installing the unit, connect the wiring temporarily, making sure it is all connected up properly, and the unit and the system work properly.
- Use only the parts included with the unit to ensure proper installation. The use of unauthorized parts can cause malfunctions.
- Consult with your nearest dealer if installation requires the drilling of holes or other modifications of the vehicle.
- Install the unit where it does not get in the driver's way and cannot injure the passenger if there is a sudden stop, like an emergency stop.
- The semiconductor laser will be damaged if it overheats, so don't install the unit anywhere hot — for instance, near a heater outlet.

- If installation angle exceeds 60° from horizontal, the unit might not give its optimum performance. (Fig. 3)

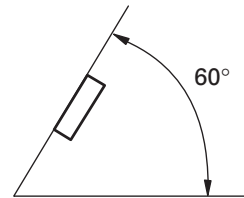

Fig. 3

- The cords must not cover up the area shown in the figure below. This is necessary to allow the amplifiers to radiate freely. (Fig. 4)

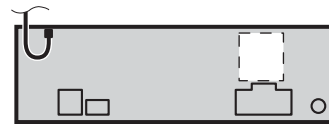

Fig. 4

DIN Front/Rear-mount

This unit can be properly installed either from “Front” (conventional DIN Front-mount) or “Rear” (DIN Rear-mount installation, utilizing threaded screw holes at the sides of unit chassis). For details, refer to the following illustrated installation methods.

DIN Front-mount

Installation with the rubber bush (Fig. 5)

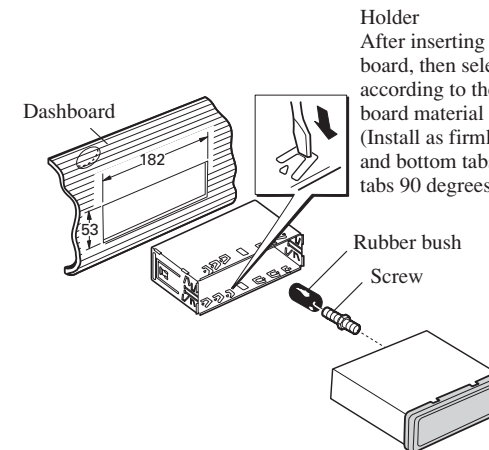

Holder
After inserting the holder into the dashboard, then select the appropriate tabs according to the thickness of the dashboard material and bend them. (Install as firmly possible using the top and bottom tabs. To secure, bend the tabs 90 degrees.)

Fig. 5

Installation without the rubber bush (Fig. 6)

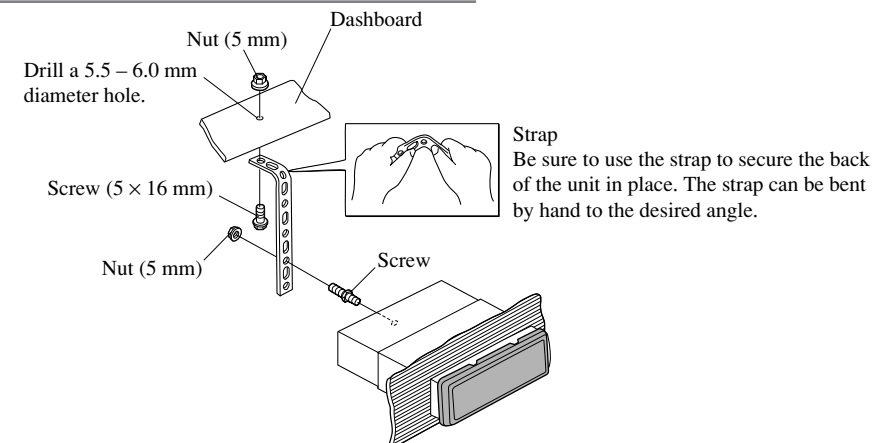

Strap
Be sure to use the strap to secure the back of the unit in place. The strap can be bent by hand to the desired angle.

Fig. 6

Removing the Unit (Fig. 7) (Fig. 8)

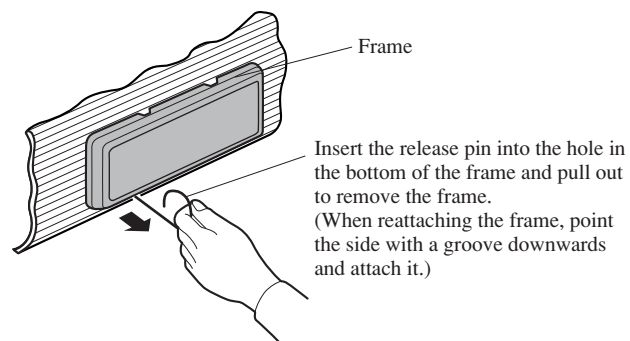

Fig. 7

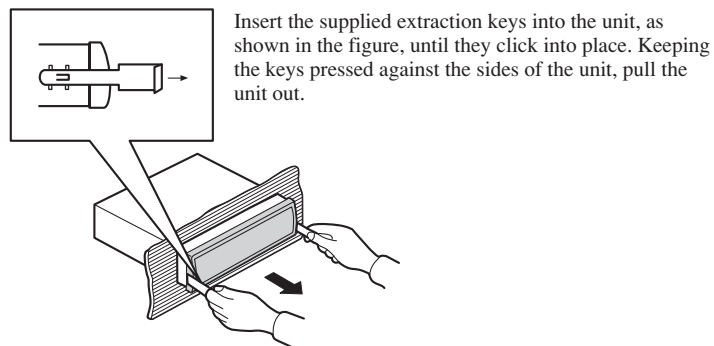

Fig. 8

DIN Rear-mount

Installation using the screw holes on the side of the unit

1. Remove the frame. (Fig. 9)

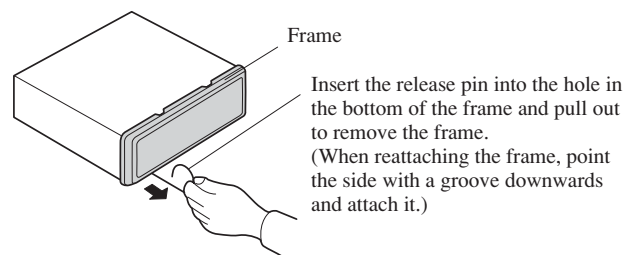

Fig. 9

2. Fastening the unit to the factory radio mounting bracket. (Fig. 10) (Fig. 11)

Select a position where the screw holes of the bracket and the screw holes of the head unit become aligned (are fitted), and tighten the screws at 2 places on each side. Use either binding screws (5 × 8 mm) or flush surface screws (5 × 9 mm), depending on the shape of the screw holes in the bracket.

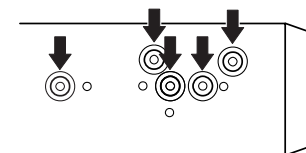

Fig. 10

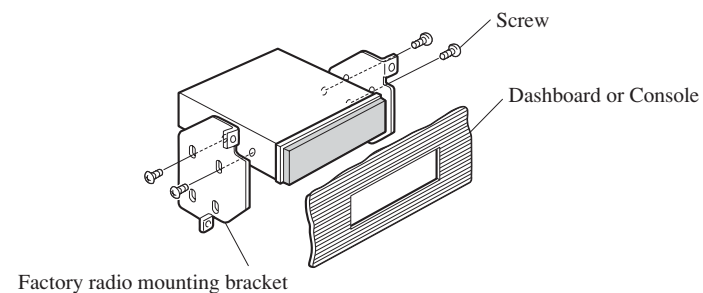

Fig.11

About the fixing screws for the front panel

If you do not operate the removing and attaching the front panel function, use the supplied fixing screw to fix the front panel to this unit.

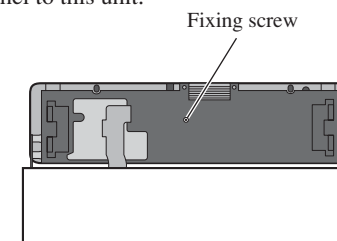

Fig. 12

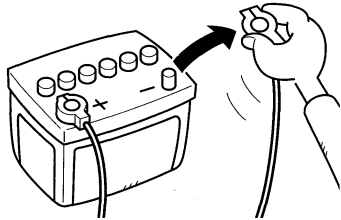

Fig.1

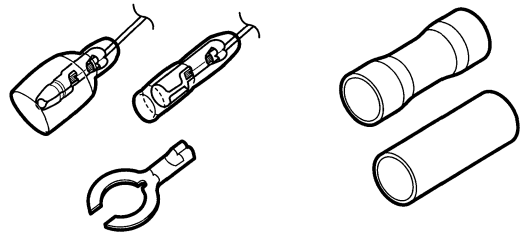

Fig.2

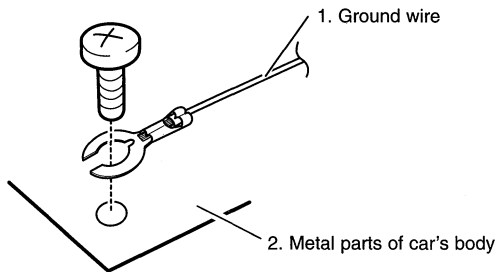

Fig.3

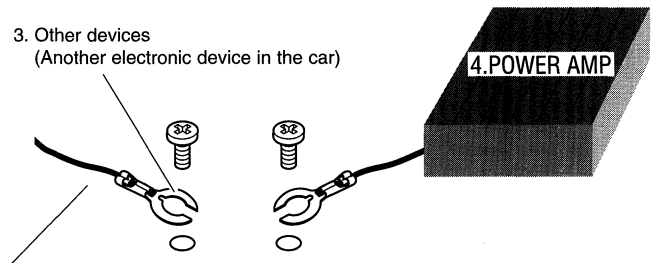

Fig.4

WARNING

Always follow the instructions below when connecting or installing parts. Not following the instructions below may result in the malfunction of this unit. Additionally, if the parts to this unit malfunction the unit may emit smoke or catch fire.

- Always remove a connector from the \ominus battery terminal before beginning any connection or installing work. (Fig.1)
- Ensure that the power cord, the ground wire and the speaker are all properly connected. We recommend that you use a plug and a receptacle, solderless contact and a Y connector. (Fig.2)
- When installing this unit, always connect the ground wire first. Ensure that the ground wire is properly connected to metal parts of the car's body. (Fig.3)
 1. Ground wire
 2. Metal parts of car's body
- Connect to this unit only high-powered speakers of over 50W and with impedance between 4 and 8 ohms. Though there are speaker systems with low impedance between 1 and 3 ohms, you must not connect these to this unit.
- When connecting the power amp (sold separately) to this unit ensure that the ground wire for the power amp is properly connected to metal parts of the car's body. Connect the ground wire of the power amp with a different screw from the one you used to connect the ground wire for this unit or any other device. Should the screw for the power amp's ground wire loosen or fall out, it may result in this unit emitting smoke or malfunctioning. (Fig.4)
 3. Other devices (Another electronic device in the car)
 4. POWER AMP
- Cover any terminals not connected with insulation tape so they do not make contact with metal.
- Do not change the speaker connections while this unit is in operation.

If you have any questions regarding the connection or installation or parts, consult your local dealer.

ADVERTENCIA

Siga siempre estas instrucciones antes de conectar o instalar piezas. De lo contrario, puede que esta unidad no funcione correctamente. Además, si las piezas de esta unidad no funcionan correctamente, la unidad puede expulsar humo o fuego.

- Extraiga siempre un conector del terminal de batería \ominus antes de realizar cualquier conexión o instalación. (Fig.1)
- Asegúrese de que el cable de corriente, el cable de conexión a tierra y el altavoz están correctamente conectados. Le recomendamos que utilice un enchufe y un receptáculo, un contacto sin soldadura y un conector en Y. (Fig.2)
- Cuando instale esta unidad, conecte siempre el cable de conexión a tierra en primer lugar. Asegúrese de que el cable de conexión a tierra está correctamente conectado a las partes metálicas de la carrocería del automóvil. (Fig.3)
 1. Cable de conexión a tierra
 2. Partes metálicas de la carrocería del automóvil
- Conecte a esta unidad únicamente altavoces de alta potencia, de más de 50 W y con una impedancia de entre 4 y 8 ohmios. Aunque existen sistemas de altavoces con baja impedancia entre 1 y 3 ohmios, no debe conectarlos a esta unidad.
- Cuando conecte el amplificador de potencia (vendido por separado) a esta unidad, asegúrese de que el cable de conexión a tierra del amplificador de potencia está conectado correctamente a las partes metálicas de la carrocería del automóvil. Conecte el cable de conexión a tierra del amplificador de potencia con un tornillo distinto del utilizado para conectar el cable de conexión a tierra de esta unidad o cualquier otro dispositivo. En caso de que el tornillo del cable de conexión a tierra del amplificador de potencia se afloje o se suelte, la unidad puede expulsar humo o dejar de funcionar correctamente. (Fig.4)
 3. Otros dispositivos (otro dispositivo electrónico del automóvil)
 4. AMPLIFICADOR DE POTENCIA
- Cubra cualquier terminal no conectado con cinta aislante para que no haga contacto con el metal.
- No cambie las conexiones del altavoz mientras esta unidad esté en funcionamiento.

Si tiene alguna pregunta en relación con la conexión o la instalación de piezas, consulte a su distribuidor local.

AVERTISSEMENT

Veillez toujours suivre les instructions indiquées ci-dessous lors du branchement ou de l'installation des pièces. Ne pas suivre les instructions indiquées ci-dessous peut entraîner un mauvais fonctionnement de l'unité. En outre, si les pièces de cette unité fonctionnent mal, de la fumée pourra sortir de l'unité ou cette dernière pourra prendre feu.

- Assurez-vous de toujours enlever un connecteur de la prise \ominus de la batterie avant de effectuer un branchement ou un travail d'installation. (Fig.1)
- Assurez-vous que le cordon d'alimentation, le fil de terre et l'enceinte sont branchés correctement. Nous vous recommandons d'utiliser une fiche et une prise de courant (femelle), un contact sans soudure et un raccord en Y. (Fig.2)
- Quand vous installez l'unité, veuillez toujours brancher le fil de terre en premier. Assurez-vous que le fil de terre est branché correctement aux pièces métalliques de la carrosserie de la voiture. (Fig.3)
 1. Fil de terre
 2. Pièces métalliques de la carrosserie de la voiture
- Assurez-vous de ne brancher à cette unité que des enceintes à haute puissance de plus de 50 W et d'une impédance entre 4 et 8 ohms. Même s'il existe des systèmes d'enceintes avec une impédance basse entre 1 et 3 ohms, vous ne devez pas brancher ce type d'enceintes à l'unité.
- Quand vous branchez l'amplificateur de puissance (vendu séparément) à cette unité, assurez-vous que le fil de terre de l'amplificateur de puissance est branché correctement aux pièces métalliques de la carrosserie de la voiture. Branchez le fil de terre de l'amplificateur de puissance avec un tournevis différent de celui que vous avez utilisé pour brancher le fil de terre à l'unité ou un autre dispositif. Si la vis du fil de terre de l'amplificateur de puissance se desserre ou tombe, de la fumée pourra sortir de l'unité ou elle fonctionnera mal. (Fig.4)
 3. Autres dispositifs (Un autre dispositif électronique dans la voiture)
 4. AMPLIFICATEUR DE PUISSANCE
- Couvrez toutes les prises qui ne sont pas branchées avec du ruban isolant pour qu'elles ne soient pas en contact avec du métal.
- Ne changez pas les branchements de l'enceinte quand l'unité est en marche.

Si vous avez des questions sur le branchement ou l'installation des pièces, veuillez consulter votre revendeur local.

ADVERTÊNCIA

Siga sempre as seguintes instruções quando realizar a ligação ou instalação de peças. O não cumprimento das seguintes instruções pode resultar no funcionamento incorrecto desta unidade. Para além disso, se as peças desta unidade não funcionarem correctamente, a unidade pode produzir fumo e incendiar.

- Retire sempre um ligador do terminal da bateria \ominus antes de realizar qualquer trabalho de ligação ou instalação. (Fig.1)
- Certifique-se de que o cabo de alimentação, o fio terra e a coluna estão devidamente ligados. Recomendamos a utilização de uma ficha e de uma tomada, de um contacto sem solda e de um conector em Y. (Fig.2)
- Quando instalar esta unidade, ligue sempre em primeiro lugar o fio terra. Certifique-se de que o fio terra está devidamente ligado a partes metálicas da carroçaria do automóvel. (Fig.3)
 1. Fio terra
 2. Peças metálicas da carroçaria do automóvel
- Ligue a esta unidade apenas a colunas de elevado desempenho com potência superior a 50W e com impedância entre 4 e 8 ohms. Embora existam colunas com baixa impedância, entre 1 e 3 ohms, não deve ligá-las a esta unidade.
- Quando ligar o amplificador (vendido em separado) a esta unidade, certifique-se de que o fio terra para o amplificador está devidamente ligado a partes metálicas da carroçaria do automóvel. Ligue o fio terra do amplificador com um parafuso diferente do utilizado para ligar o fio terra a esta unidade ou a qualquer outro dispositivo. Se o parafuso do amplificador se soltar ou cair, poderá fazer com que a unidade comece a deitar fumo ou a funcionar mal. (Fig.4)
 3. Outros dispositivos (Outra unidade electrónica no automóvel)
 4. AMPLIFICADOR
- Tape todos os terminais não ligados com fita isoladora de forma a que não fiquem em contacto com o metal.
- Não mude as ligações das colunas enquanto a unidade estiver a funcionar.

Em caso de dúvidas relacionadas com a ligação ou instalação de peças, consulte o seu distribuidor local.

<KMMNF> <CRP1310-A/N>

About the demo mode

This product features two demonstration modes. One is the reverse mode and the other is the feature demo mode.

Reverse mode

If you do not carry out an operation within about 30 seconds, screen indications will start to reverse, and then continue reversing every 10 seconds. Pressing the button 5 when power to this product is switched off while the ignition switch is set to ACC or ON cancels the reverse mode. Press the button 5 again to start the reverse mode.

- Some entertainment displays may not operate the reverse mode.

Feature demo

The feature demo automatically starts when power to this product is switched off while the ignition switch is set to ACC or ON. Pressing the button 6 during feature demo operation cancels the feature demo mode. Press the button 6 again to start the feature demo mode. Remember that if the feature demo continues operating when the car engine is switched OFF, it may drain battery power.

Note:

- The red lead (ACC) of this product should be connected to a terminal coupled with ignition switch ON or OFF operations. If this is not done, the vehicle battery may be drained.

Zum Demonstrationsmodus

Dieses Gerät hat zwei verschiedene Demonstrationsarten. Eine davon ist der Umkehrmodus, und die andere ist der Demonstrationsmodus für die Eigenschaften.

Umkehrmodus

Wenn Sie 30 Sekunden lang keine Bedienung durchführen, so wird die Display-Anzeige umgekehrt, und anschließend wird sie jeweils alle 10 Sekunden wieder umgekehrt. Durch Drücken der Taste 5 beim Ausschalten der Stromversorgung für dieses Gerät während der Zündschlüssel auf ACC oder ON steht wird der Umkehrmodus ausgeschaltet. Durch erneutes Drücken der Taste 5 wird der Umkehrmodus wieder eingeschaltet.

- Gewisse Entertainment-Displays schalten unter Umständen nicht auf den Umkehrmodus.

Demonstration der Eigenschaften

Die Demonstration der Eigenschaften dieses Gerätes beginnt automatisch, wenn die Stromversorgung für dieses Gerät ausgeschaltet wird, während der Zündschlüssel auf ACC oder ON steht. Durch Drücken der Taste 6 während der Demonstration der Eigenschaften wird dieser Demonstrationsmodus ausgeschaltet. Durch erneutes Drücken der Taste 6 wird der Demonstrationsmodus wieder eingeschaltet. Bitte beachten Sie, dass fortgesetzter Betrieb im Demonstrationsmodus bei abgestelltem Motor die Batterie erschöpfen kann.

Hinweis:

- Der rote Leiter (ACC) dieses Gerätes sollte an eine Klemme angeschlossen werden, die durch den Zündschlüssel ein- und ausgeschaltet wird. Wenn dies nicht der Fall ist, kann die Fahrzeugbatterie erschöpft werden.

Riguardo il modo di dimostrazione

Questo prodotto dispone di due modi di dimostrazione. Uno è il modo di inversione e l'altro è il modo di dimostrazione funzioni.

Modo di inversione

Se non si esegue alcuna operazione entro 30 secondi circa, le indicazioni sullo schermo iniziano a essere invertite e continuano a invertirsi ogni 10 secondi. Se si preme il tasto 5 ad unità spenta mentre l'interruttore di ignizione è regolato su ACC o ON si disattiva il modo di inversione. Premere di nuovo il tasto 5 per attivare il modo di inversione.

- Alcune indicazioni di intrattenimento potrebbero non eseguire il modo di inversione.

Dimostrazione delle funzioni

La dimostrazione delle funzioni si avvia automaticamente quando l'unità viene spenta mentre l'interruttore di ignizione è regolato su ACC o ON. Se si preme il tasto 6 durante la dimostrazione delle funzioni, il modo di dimostrazione delle funzioni viene disattivato. Premere di nuovo il tasto 6 per attivare il modo di dimostrazione delle funzioni. Ricordare che se la dimostrazione delle funzioni continua quando il motore dell'auto è spento, può scaricare la batteria.

Nota:

- Il cavo rosso (ACC) di questo prodotto deve essere collegato ad un terminale accoppiato con le operazioni ON e OFF dell'interruttore di ignizione. Altrimenti la batteria dell'auto può scaricarsi.

Acerca del modo de demostración

Este producto presenta dos modos de demostración. Uno es el modo de demostración en inversión, y el otro el es modo de demostración de características.

Modo de inversión

Si no realiza ninguna operación antes de que transcurran unos 30 segundos, las indicaciones de la pantalla comienzan a retroceder, y luego continúan retrocediendo cada 10 segundos. Si presiona el botón 5 al apagar este producto con el interruptor de encendido en la posición ACC u ON, el modo de inversión se cancela. Presione el botón 5 otra vez para iniciar el modo de inversión.

- Puede que algunas visualizaciones de entretenimiento no funcionen en el modo de inversión.

Demostración de las características

La demostración de características se inicia automáticamente cuando apaga este producto mientras el interruptor de encendido está en la posición ACC u ON. Presione el botón 6 durante la operación de demostración de características para cancelar el modo de demostración de características. Presione el botón 6 otra vez para iniciar el modo de demostración de características.

Tenga en cuenta que si la demostración de características continúa funcionando con el motor del coche apagado, la batería podrá descargarse.

Nota:

- El conductor rojo (ACC) de este producto debe ser conectado al terminal enlazado con las operaciones de conexión y desconexión del interruptor de encendido. De lo contrario, se podría descargar la batería del vehículo.

Quelques mots sur le mode démonstration

Cet appareil possède deux modes de démonstration. Un mode inverse et un mode de démonstration des possibilités.

Mode inverse

Si vous ne procédez à aucune opération pendant environ 30 secondes, les indications affichées sur l'écran s'inversent, et continuent de s'inverser toutes les 10 secondes. Si vous appuyez sur la touche 5 alors que l'appareil n'est pas en service et que le contacteur d'allumage est sur la position ACC ou ON, a pour effet d'annuler le mode inverse. Appuyez une nouvelle fois sur la touche 5 pour relancer le mode inverse.

- Certaines pages de divertissement ne donnent pas lieu au mode inverse.

Mode de démonstration des possibilités

La démonstration des possibilités commence automatiquement lorsque l'appareil est mis hors service et que le contacteur d'allumage est sur la position ACC ou ON. Si vous appuyez sur la touche 6 pendant la démonstration, vous annulez cette démonstration. Appuyez une nouvelle fois sur la touche 6 pour relancer la démonstration. Sachez que si la démonstration se poursuit alors que le moteur est arrêté, la batterie sera rapidement déchargée.

Remarque:

- Le conducteur rouge (ACC) de cet appareil doit être relié à une borne qui se trouve connectée aux positions ON ou OFF du contacteur d'allumage. Si ce n'est pas le cas, la batterie du véhicule peut être déchargée.

Over de demo-functie

Dit product heeft twee demonstratiefuncties. De ene is een terugbladerende demonstratie en de andere is een demonstratie van de kenmerken van het toestel.

Terugbladerende demonstratie

Als u niet binnen ongeveer 30 seconden een handeling uitvoert, zullen de aanduidingen op het scherm om de 10 seconden terug beginnen te bladeren naar de vorige instellingen. Als u op toets 5 drukt terwijl dit product is uitgeschakeld en het contact op ACC of ON staat, zal de terugbladerende demonstratie worden geannuleerd. Druk nog eens op toets 5 om de terugbladerende demonstratie weer te hervatten.

- Het is mogelijk dat de terugbladerende demonstratiefunctie niet werkt op sommige speciaal voor amusementsdoeleinden ontworpen displays.

Demonstratie kenmerken

De demonstratie van de kenmerken en functies van dit toestel zal automatisch beginnen wanneer dit toestel wordt uitgeschakeld terwijl het contact op ACC of ON staat. Als u op toets 6 drukt terwijl de demonstratie van de kenmerken bezig is, zal deze worden geannuleerd. Druk nog eens op toets 6 om de demonstratie van de kenmerken weer te laten beginnen. Vergeet niet dat op den duur de accu leeg kan raken als u de demonstratie van de kenmerken van het toestel door laat gaan wanneer de motor van uw auto uit is.

Opmerking:

- De rode draad (ACC) van dit product moet worden verbonden met een aansluiting die is gekoppeld aan de ON of OFF stand van het contact. Doet u dit niet, dan kan het product de accu leeg trekken.



PIONEER ELECTRONICS (USA) INC.

PIONEER ELECTRONICS OF CANADA, INC.

LIMITED WARRANTY

WARRANTY VALID ONLY IN COUNTRY OF PRODUCT PURCHASE

WARRANTY

Pioneer Electronics (USA) Inc. (PUSA), and Pioneer Electronics Of Canada, Inc. (POC), warrant that products distributed by PUSA in the U.S.A., and by POC in Canada that fail to function properly under normal use due to a manufacturing defect when installed and operated according to the owner's manual enclosed with the unit will be repaired or replaced with a unit of comparable value, at the option of PUSA or POC, without charge to you for parts or actual repair work. Parts supplied under this warranty may be new or rebuilt at the option of PUSA or POC.

THIS LIMITED WARRANTY APPLIES TO THE ORIGINAL OR ANY SUBSEQUENT OWNER OF THIS PIONEER PRODUCT DURING THE WARRANTY PERIOD PROVIDED THE PRODUCT WAS PURCHASED FROM AN AUTHORIZED PIONEER DISTRIBUTOR/DEALER IN THE U.S.A. OR CANADA. YOU WILL BE REQUIRED TO PROVIDE A SALES RECEIPT OR OTHER VALID PROOF OF PURCHASE SHOWING THE DATE OF ORIGINAL PURCHASE OR, IF RENTED, YOUR RENTAL CONTRACT SHOWING THE PLACE AND DATE OF FIRST RENTAL. IN THE EVENT SERVICE IS REQUIRED, THE PRODUCT MUST BE DELIVERED WITHIN THE WARRANTY PERIOD, TRANSPORTATION PREPAID, ONLY FROM WITHIN THE COUNTRY OF PURCHASE AS EXPLAINED IN THIS DOCUMENT. YOU WILL BE RESPONSIBLE FOR REMOVAL AND INSTALLATION OF THE PRODUCT. PUSA OR POC, AS APPROPRIATE, WILL PAY TO RETURN THE REPAIRED OR REPLACEMENT PRODUCT TO YOU WITHIN THE COUNTRY OF PURCHASE.

PRODUCT WARRANTY PERIOD

Car Stereo Products 1 Year 1 Year

The warranty period for retail customers who rent the product commences upon the date product is first put into use (a) during the rental period or (b) retail sale, whichever occurs first.

WHAT IS NOT COVERED

IF THIS PRODUCT WAS PURCHASED FROM AN UNAUTHORIZED DISTRIBUTOR, THERE ARE NO WARRANTIES, EXPRESS OR IMPLIED, INCLUDING THE IMPLIED WARRANTY OF MERCHANTABILITY AND THE IMPLIED WARRANTY OF FITNESS FOR A PARTICULAR PURPOSE AND THIS PRODUCT IS SOLD STRICTLY "AS IS" AND "WITH ALL FAULTS".

PIONEER SHALL NOT BE LIABLE FOR ANY CONSEQUENTIAL AND/OR INCIDENTAL DAMAGES.

PIONEER DOES NOT WARRANT ANY PRODUCT LISTED ABOVE WHEN IT IS USED IN A TRADE OR BUSINESS OR IN ANY INDUSTRIAL OR COMMERCIAL APPLICATION.

THIS WARRANTY DOES NOT APPLY IF THE PRODUCT HAS BEEN SUBJECTED TO POWER IN EXCESS OF ITS PUBLISHED POWER RATING.

THIS WARRANTY DOES NOT COVER DISPLAY SCREENS DAMAGED BY STATIC, NON-MOVING, IMAGES APPLIED FOR LENGTHY PERIODS (BURN-IN).

THIS WARRANTY DOES NOT COVER THE CABINET OR ANY APPEARANCE ITEM, USER ATTACHED ANTENNA, ANY DAMAGE TO RECORDS OR RECORDING TAPES OR DISCS, ANY DAMAGE TO THE PRODUCT RESULTING FROM ALTERATIONS, MODIFICATIONS NOT AUTHORIZED IN WRITING BY PIONEER, ACCIDENT, MISUSE OR ABUSE, DAMAGE DUE TO LIGHTNING OR TO POWER SURGES, SUBSEQUENT DAMAGE FROM LEAKING, DAMAGE FROM INOPERATIVE BATTERIES, OR THE USE OF BATTERIES NOT CONFORMING TO THOSE SPECIFIED IN THE OWNER'S MANUAL.

THIS WARRANTY DOES NOT COVER THE COST OF PARTS OR LABOR WHICH WOULD BE OTHERWISE PROVIDED WITHOUT CHARGE UNDER THIS WARRANTY OBTAINED FROM ANY SOURCE OTHER THAN A PIONEER AUTHORIZED SERVICE COMPANY OR OTHER DESIGNATED LOCATION. THIS WARRANTY DOES NOT COVER DEFECTS OR DAMAGE CAUSED BY THE USE OF UNAUTHORIZED PARTS OR LABOR OR FROM IMPROPER MAINTENANCE.

ALTERED, DEFACED, OR REMOVED SERIAL NUMBERS VOID THIS ENTIRE WARRANTY

NO OTHER WARRANTIES

IN THE U.S.A. - PIONEER LIMITS ITS OBLIGATIONS UNDER ANY IMPLIED WARRANTIES INCLUDING, BUT NOT LIMITED TO, THE IMPLIED WARRANTIES OF MERCHANTABILITY AND FITNESS FOR A PARTICULAR PURPOSE, TO A PERIOD NOT TO EXCEED THE WARRANTY PERIOD. NO WARRANTIES SHALL APPLY AFTER THE WARRANTY PERIOD. SOME STATES DO NOT ALLOW LIMITATIONS ON HOW LONG AN IMPLIED WARRANTY LASTS AND SOME STATES DO NOT ALLOW THE EXCLUSIONS OR LIMITATIONS OF INCIDENTAL OR CONSEQUENTIAL DAMAGES, SO THE ABOVE LIMITATIONS OR EXCLUSIONS MAY NOT APPLY TO YOU. THIS WARRANTY GIVES YOU SPECIFIC LEGAL RIGHTS AND YOU MAY HAVE OTHER RIGHTS WHICH MAY VARY FROM STATE TO STATE.

IN CANADA - EXCEPT AS EXPRESSLY PROVIDED HEREIN, THERE ARE NO REPRESENTATIONS, WARRANTIES, OBLIGATIONS OR CONDITIONS, IMPLIED, STATUTORY OR OTHERWISE, APPLICABLE TO THIS PRODUCT.

TO OBTAIN SERVICE (EXCEPT CAR SPEAKERS SOLD IN THE U.S.A. ONLY)

PUSA and POC have appointed a number of Authorized Service Companies throughout the U.S.A. and Canada should your product require service. To receive warranty service you need to present your sales receipt or, if rented, your rental contract showing place and date of original owner's transaction. If shipping the unit you will need to package it carefully and send it, transportation prepaid by a traceable, insured method, to an Authorized Service Company. Package the product using adequate padding material to prevent damage in transit. The original container is ideal for this purpose. Include your name, address and telephone number where you can be reached during business hours.

TO OBTAIN SERVICE ON CAR SPEAKERS SOLD IN THE U.S.A.

Should your car speaker require service please return it to your retail dealer for exchange. To receive warranty service you will need to present your sales receipt showing place and date of original owner's retail purchase. If, for any reason, you can not exchange speakers at the selling dealer call Customer Support at the number below.

On all complaints and concerns in the U.S.A. call Customer Support at 1-800-421-1404, or, in Canada, call Customer Satisfaction at (905) 479-4411.

IN THE U.S.A.

For hook-up and operation of your unit or to locate an Authorized Service Company, please call or write:

CUSTOMER SUPPORT DIVISION
PIONEER ELECTRONICS (USA) INC.
P.O. BOX 1760
LONG BEACH, CALIFORNIA 90801
1-800-421-1404

http://www.pioneerelectronics.com

IN CANADA

For additional information on this warranty, please call or write:

CUSTOMER SATISFACTION GROUP
PIONEER ELECTRONICS OF CANADA, INC.
300 ALLSTATE PARKWAY
MARKHAM, ON L3R 0P2
(905) 479-4411
1-877-283-5901

http://www.pioneerelectronics.com

DISPUTE RESOLUTION

IN THE U.S.A. - Following our response to any initial request to Customer Support, should a dispute arise between you and Pioneer, Pioneer makes available its Complaint Resolution Program to resolve the dispute. The Complaint Resolution Program is available to you without charge. You are required to use the Complaint Resolution Program before you exercise any rights under, or seek any remedies, created by Title 1 of the Magnuson-Moss Warranty-Federal Trade Commission Improvement Act, 15 U.S.C. 2301 et seq. To use the Complaint Resolution Program call 1-800-421-1404 and explain to the customer service representative the problem you are experiencing, steps you have taken to have the product repaired during the warranty period and the name of the authorized Distributor/Dealer from whom the Pioneer product was purchased. After the complaint has been explained to the representative, a resolution number will be issued. Within 40 days of receiving your complaint, Pioneer will investigate the dispute and will either: (1) respond to your complaint in writing informing you what action Pioneer will take, and in what time period, to resolve the dispute; or (2) respond to your complaint in writing informing you why it will not take any action.

IN CANADA - Call the Customer Satisfaction Manager at (905) 946-7446 to discuss your complaint and to obtain a prompt resolution.

RECORD THE PLACE AND DATE OF PURCHASE FOR FUTURE REFERENCE

Model No. _____ Serial No. _____ Purchase Date _____

Purchased From _____

KEEP THIS INFORMATION AND YOUR SALES RECEIPT IN A SAFE PLACE

< ARY1048-E/N >

Printed in Thailand